

February, 2016

Attn.: _____

HIROSE ELECTRIC CO., LTD.

5-23, OSAKI 5-CHOME, SHINAGAWA-KU, TOKYO, JAPAN

Notice of Change in Insulation Material (Polyamide Resin) for DF3 and DF13 Series Connectors and Request for Your Acknowledgement

Hirose would like to take this opportunity to thank you sincerely for your support, and we hope this letter finds you well and prosperous.

We are writing today to inform you that we will change materials, etc., in board-to-wire connectors, DF3 and DF13 series for the following reasons.

We sincerely apologize for any inconvenience this may cause.

We request that you kindly offer your consent to this matter.

1. Products Affected

■ DF3 Series

DF3(D)Z-●P-2V(**)

DF3(D)Z-●P-2H(**)

● = Number of pins (2-15)

** = Specification number (The change applies to the connectors of all specification numbers.)

■ DF13 Series

DF13 (A)-●DP-1.25V(**)

● = Number of pins (10, 20, 30, 40)

** = Specification number (The change applies to the connectors of all specification numbers.)

Names of Products Before and After the Change (Representative Products)

	Current Products	Products after the Change
DF3 Series with a boss	DF3Z-●P-2V(**) DF3Z-●P-2H(**)	DF3E-●P-2V(**) DF3E-●P-2H(**)
DF3 Series without a boss	DF3DZ-●P-2V(**) DF3DZ-●P-2H(**)	DF3EA-●P-2V(**) DF3EA-●P-2H(**)
DF13 Series with a boss	DF13-●DP-1.25V(**)	DF13E-●DP-1.25V(**)
DF13 Series without a boss	DF13A-●DP-1.25V(**)	DF13EA-●DP-1.25V(**)

* See Attachment 1 "List of Names of Products Before and After the Change" for product details.

2. Description of Change

We will change the manufacturers and grades of insulation materials as shown in the table below.

Products	Change Part	Description of Change	Before change	After change
DF3, DF13	Insulation case	Insulation material manufacturer	DSM Japan	Kuraray Co., Ltd.
		Manufacturer's part number (grade)	TS250F6D (PA46)	GN2330 (PA9T)
		Flame-resistant grade	UL94V-0	UL94V-0
DF13	Absorption cap	Insulation material manufacturer	Mitsui Chemicals, Inc.	Kuraray Co., Ltd.
		Manufacturer's part number (grade)	CH230N(PA6T)	GN2330 (PA9T)
		Flame-resistant grade	UL94V-0	UL94V-0

3. Reason for Change

We will change to materials with low water-absorbing property to suppress resin blisters which may occur at the time of reflow.

- Comparison of water absorption rates before and after the change (Material's physical property value)

Part	Before change	After change
Insulation case	1.5% (*1)	1.0% (*2)
Absorption cap	2.2% (*2)	1.0% (*2)

(*1) Humidity control condition: 23°C × 50%RH

(*2) Humidity control condition: 40°C × 95%RH

4. Differences Resulting from the Change

- (1) Change in the color tone of the insulation material

The color tone will be slightly different after change.

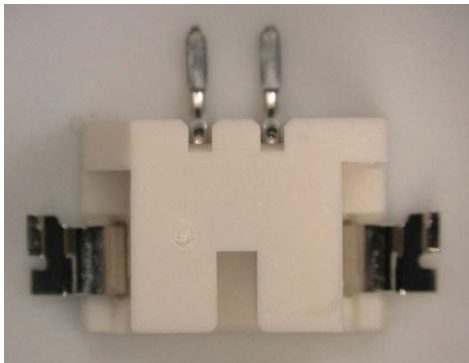

Before change

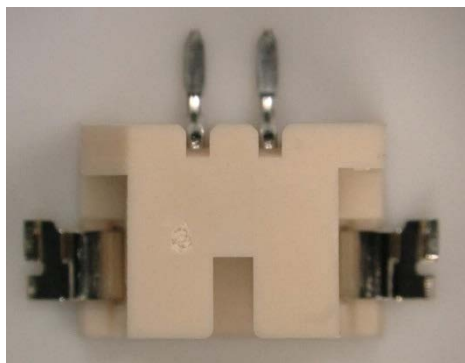

After change

(the color will become darker)

* The product in the above picture is a DF3 series product (H type).

The color tone of the products after the change will be as shown in the above picture.

(2) Change in product form

The forms of products will slightly change.
See Attachment 2 "Description of Change of Product Form."

(3) Discontinuation of sales of products using moisture-proof packaging with silica gel

Since materials with a low water-absorbing property will be used after the change, we will discontinue the sales of products using the above packaging specification.

(4) Difference in functions

We will guarantee the product specification no different from the existing products for the products after change.

- 1) Counterpart mating connectors can be used as usual after the change of insulation material of the products.
- 2) The insulation material of counterpart mating connectors will not be changed.
- 3) Although the products after the change satisfy the RoHS directive, inclusions of chemical substances, etc., have changed. Please contact a Hirose sales representative concerning green procurement.

5. Schedule of Implementation of Change

- | | |
|---|------------------|
| (1) Last date for receiving orders for the current products | July 30, 2016 |
| (2) Start date for receiving orders for the new products | August 1, 2016 |
| (3) Last shipping date for the current products | January 31, 2017 |

6. Confirmation of Your Acknowledgement

We kindly request that you let a Hirose account representative know you acknowledge this matter by July 20, 2016. In the absence of a response by this date, please be advised that you will be delivered products that have been changed as described above. If you should have any questions, please feel free to contact a Hirose account representative.

Attached documents:

- Attachment 1. List of Names of Products Before and After the Change
- Attachment 2. Description of Change of Product Form

Attachment 1. List of Names of Products Before and After the Change

No.	Names of Products Affected by the Change		Product Name after Change		Remarks	
	Product Code	Product Name	Product Code	Product Name	Specification before change	Specification after change
1	CL543-1028-4-20	DF3Z-2P-2V(20)	CL543-0357-0-20	DF3E-2P-2V(20)	Tin plated Magazine packaging	Tin plated Magazine packaging
2	CL543-1029-7-20	DF3Z-3P-2V(20)	CL543-0358-0-20	DF3E-3P-2V(20)		
3	CL543-1030-6-20	DF3Z-4P-2V(20)	CL543-0359-0-20	DF3E-4P-2V(20)		
4	CL543-1031-9-20	DF3Z-5P-2V(20)	CL543-0360-0-20	DF3E-5P-2V(20)		
5	CL543-1032-1-20	DF3Z-6P-2V(20)	CL543-0361-0-20	DF3E-6P-2V(20)		
6	CL543-1033-4-20	DF3Z-7P-2V(20)	CL543-0362-0-20	DF3E-7P-2V(20)		
7	CL543-1034-7-20	DF3Z-8P-2V(20)	CL543-0363-0-20	DF3E-8P-2V(20)		
8	CL543-1035-0-20	DF3Z-9P-2V(20)	CL543-0364-0-20	DF3E-9P-2V(20)		
9	CL543-1036-2-20	DF3Z-10P-2V(20)	CL543-0365-0-20	DF3E-10P-2V(20)		
10	CL543-1038-8-20	DF3Z-12P-2V(20)	CL543-0367-0-20	DF3E-12P-2V(20)		
11	CL543-1056-0-20	DF3DZ-2P-2V(20)	CL543-0315-0-20	DF3EA-2P-2V(20)		
12	CL543-1058-5-20	DF3DZ-4P-2V(20)	CL543-0317-0-20	DF3EA-4P-2V(20)		
13	CL543-1060-7-20	DF3DZ-6P-2V(20)	CL543-0319-0-20	DF3EA-6P-2V(20)		
14	CL543-1061-0-20	DF3DZ-7P-2V(20)	CL543-0320-0-20	DF3EA-7P-2V(20)		
15	CL543-1042-5-20	DF3Z-2P-2H(20)	CL543-0342-0-20	DF3E-2P-2H(20)		
16	CL543-1043-8-20	DF3Z-3P-2H(20)	CL543-0344-0-20	DF3E-3P-2H(20)		
17	CL543-1044-0-20	DF3Z-4P-2H(20)	CL543-0345-0-20	DF3E-4P-2H(20)		
18	CL543-1045-3-20	DF3Z-5P-2H(20)	CL543-0346-0-20	DF3E-5P-2H(20)		
19	CL543-1046-6-20	DF3Z-6P-2H(20)	CL543-0347-0-20	DF3E-6P-2H(20)		
20	CL543-1047-9-20	DF3Z-7P-2H(20)	CL543-0348-0-20	DF3E-7P-2H(20)		
21	CL543-1050-3-20	DF3Z-10P-2H(20)	CL543-0351-0-20	DF3E-10P-2H(20)		
22	CL543-1054-4-20	DF3Z-14P-2H(20)	CL543-0355-0-20	DF3E-14P-2H(20)		
23	CL543-1070-0-20	DF3DZ-2P-2H(20)	CL543-0329-0-20	DF3EA-2P-2H(20)		
24	CL543-1071-3-20	DF3DZ-3P-2H(20)	CL543-0330-0-20	DF3EA-3P-2H(20)		
25	CL543-1072-6-20	DF3DZ-4P-2H(20)	CL543-0331-0-20	DF3EA-4P-2H(20)		
26	CL543-1028-4-21	DF3Z-2P-2V(21)	CL543-0357-0-21	DF3E-2P-2V(21)		
27	CL543-1029-7-21	DF3Z-3P-2V(21)	CL543-0358-0-21	DF3E-3P-2V(21)		
28	CL543-1030-6-21	DF3Z-4P-2V(21)	CL543-0359-0-21	DF3E-4P-2V(21)		
29	CL543-1031-9-21	DF3Z-5P-2V(21)	CL543-0360-0-21	DF3E-5P-2V(21)		
30	CL543-1032-1-21	DF3Z-6P-2V(21)	CL543-0361-0-21	DF3E-6P-2V(21)		
31	CL543-1034-7-21	DF3Z-8P-2V(21)	CL543-0363-0-21	DF3E-8P-2V(21)		
32	CL543-1036-2-21	DF3Z-10P-2V(21)	CL543-0365-0-21	DF3E-10P-2V(21)		
33	CL543-1037-5-21	DF3Z-11P-2V(21)	CL543-0366-0-21	DF3E-11P-2V(21)		
34	CL543-1056-0-21	DF3DZ-2P-2V(21)	CL543-0315-0-21	DF3EA-2P-2V(21)		
35	CL543-1057-2-21	DF3DZ-3P-2V(21)	CL543-0316-0-21	DF3EA-3P-2V(21)		
36	CL543-1058-5-21	DF3DZ-4P-2V(21)	CL543-0317-0-21	DF3EA-4P-2V(21)		
37	CL543-1059-8-21	DF3DZ-5P-2V(21)	CL543-0318-0-21	DF3EA-5P-2V(21)		
38	CL543-1060-7-21	DF3DZ-6P-2V(21)	CL543-0319-0-21	DF3EA-6P-2V(21)		
39	CL543-1061-0-21	DF3DZ-7P-2V(21)	CL543-0320-0-21	DF3EA-7P-2V(21)		
40	CL543-1062-2-21	DF3DZ-8P-2V(21)	CL543-0321-0-21	DF3EA-8P-2V(21)		
41	CL543-1063-5-21	DF3DZ-9P-2V(21)	CL543-0322-0-21	DF3EA-9P-2V(21)		
42	CL543-1064-8-21	DF3DZ-10P-2V(21)	CL543-0323-0-21	DF3EA-10P-2V(21)		
43	CL543-1065-0-21	DF3DZ-11P-2V(21)	CL543-0324-0-21	DF3EA-11P-2V(21)		
44	CL543-1066-3-21	DF3DZ-12P-2V(21)	CL543-0325-0-21	DF3EA-12P-2V(21)		
45	CL543-1067-6-21	DF3DZ-13P-2V(21)	CL543-0326-0-21	DF3EA-13P-2V(21)		
46	CL543-1068-9-21	DF3DZ-14P-2V(21)	CL543-0327-0-21	DF3EA-14P-2V(21)		
47	CL543-1069-1-21	DF3DZ-15P-2V(21)	CL543-0328-0-21	DF3EA-15P-2V(21)		
48	CL543-1042-5-21	DF3Z-2P-2H(21)	CL543-0343-0-21	DF3E-2P-2H(21)		
49	CL543-1043-8-21	DF3Z-3P-2H(21)	CL543-0344-0-21	DF3E-3P-2H(21)		
50	CL543-1044-0-21	DF3Z-4P-2H(21)	CL543-0345-0-21	DF3E-4P-2H(21)		
51	CL543-1046-6-21	DF3Z-6P-2H(21)	CL543-0347-0-21	DF3E-6P-2H(21)		
52	CL543-1047-9-21	DF3Z-7P-2H(21)	CL543-0348-0-21	DF3E-7P-2H(21)		
53	CL543-1048-1-21	DF3Z-8P-2H(21)	CL543-0349-0-21	DF3E-8P-2H(21)		
54	CL543-1050-3-21	DF3Z-10P-2H(21)	CL543-0351-0-21	DF3E-10P-2H(21)		
55	CL543-1070-0-21	DF3DZ-2P-2H(21)	CL543-0329-0-21	DF3EA-2P-2H(21)		
56	CL543-1071-3-21	DF3DZ-3P-2H(21)	CL543-0330-0-21	DF3EA-3P-2H(21)		
57	CL543-1072-6-21	DF3DZ-4P-2H(21)	CL543-0331-0-21	DF3EA-4P-2H(21)		
58	CL543-1073-9-21	DF3DZ-5P-2H(21)	CL543-0332-0-21	DF3EA-5P-2H(21)		
59	CL543-1074-1-21	DF3DZ-6P-2H(21)	CL543-0333-0-21	DF3EA-6P-2H(21)		
60	CL543-1075-4-21	DF3DZ-7P-2H(21)	CL543-0334-0-21	DF3EA-7P-2H(21)		
61	CL543-1076-7-21	DF3DZ-8P-2H(21)	CL543-0335-0-21	DF3EA-8P-2H(21)		
62	CL543-1077-0-21	DF3DZ-9P-2H(21)	CL543-0336-0-21	DF3EA-9P-2H(21)		
63	CL543-1078-2-21	DF3DZ-10P-2H(21)	CL543-0337-0-21	DF3EA-10P-2H(21)		
64	CL543-1079-5-21	DF3DZ-11P-2H(21)	CL543-0338-0-21	DF3EA-11P-2H(21)		
65	CL543-1080-4-21	DF3DZ-12P-2H(21)	CL543-0339-0-21	DF3EA-12P-2H(21)		
66	CL543-1081-7-21	DF3DZ-13P-2H(21)	CL543-0340-0-21	DF3EA-13P-2H(21)		
67	CL543-1082-0-21	DF3DZ-14P-2H(21)	CL543-0341-0-21	DF3EA-14P-2H(21)		
68	CL543-1083-2-21	DF3DZ-15P-2H(21)	CL543-0342-0-21	DF3EA-15P-2H(21)		

Attachment 1. List of Names of Products Before and After the Change

No.	Names of Products Affected by the Change		Product Name after Change		Remarks	
	Product Code	Product Name	Product Code	Product Name	Specification before change	Specification after change
69	CL543-1028-4-50	DF3Z-2P-2V(50)	CL543-0357-0-50	DF3E-2P-2V(50)	Gold plated Magazine packaging	Gold plated Magazine packaging
70	CL543-1029-7-50	DF3Z-3P-2V(50)	CL543-0358-0-50	DF3E-3P-2V(50)		
71	CL543-1030-6-50	DF3Z-4P-2V(50)	CL543-0359-0-50	DF3E-4P-2V(50)		
72	CL543-1031-9-50	DF3Z-5P-2V(50)	CL543-0360-0-50	DF3E-5P-2V(50)		
73	CL543-1032-1-50	DF3Z-6P-2V(50)	CL543-0361-0-50	DF3E-6P-2V(50)		
74	CL543-1033-4-50	DF3Z-7P-2V(50)	CL543-0362-0-50	DF3E-7P-2V(50)		
75	CL543-1034-7-50	DF3Z-8P-2V(50)	CL543-0363-0-50	DF3E-8P-2V(50)		
76	CL543-1036-2-50	DF3Z-10P-2V(50)	CL543-0365-0-50	DF3E-10P-2V(50)		
77	CL543-1038-8-50	DF3Z-12P-2V(50)	CL543-0367-0-50	DF3E-12P-2V(50)		
78	CL543-1041-2-50	DF3Z-15P-2V(50)	CL543-0370-0-50	DF3E-15P-2V(50)		
79	CL543-1056-0-50	DF3DZ-2P-2V(50)	CL543-0315-0-50	DF3EA-2P-2V(50)		
80	CL543-1057-2-50	DF3DZ-3P-2V(50)	CL543-0316-0-50	DF3EA-3P-2V(50)		
81	CL543-1060-7-50	DF3DZ-6P-2V(50)	CL543-0319-0-50	DF3EA-6P-2V(50)		
82	CL543-1042-5-50	DF3Z-2P-2H(50)	CL543-0343-0-50	DF3E-2P-2H(50)		
83	CL543-1043-8-50	DF3Z-3P-2H(50)	CL543-0344-0-50	DF3E-3P-2H(50)		
84	CL543-1044-0-50	DF3Z-4P-2H(50)	CL543-0345-0-50	DF3E-4P-2H(50)		
85	CL543-1045-3-50	DF3Z-5P-2H(50)	CL543-0346-0-50	DF3E-5P-2H(50)		
86	CL543-1046-6-50	DF3Z-6P-2H(50)	CL543-0347-0-50	DF3E-6P-2H(50)		
87	CL543-1048-1-50	DF3Z-8P-2H(50)	CL543-0349-0-50	DF3E-8P-2H(50)		
88	CL543-1050-3-50	DF3Z-10P-2H(50)	CL543-0351-0-50	DF3E-10P-2H(50)		
89	CL543-1072-6-50	DF3DZ-4P-2H(50)	CL543-0331-0-50	DF3EA-4P-2H(50)		
90	CL543-1076-7-50	DF3DZ-8P-2H(50)	CL543-0335-0-50	DF3EA-8P-2H(50)		
91	CL543-1081-7-50	DF3DZ-13P-2H(50)	CL543-0340-0-50	DF3EA-13P-2H(50)		
92	CL543-1083-2-50	DF3DZ-15P-2H(50)	CL543-0342-0-50	DF3EA-15P-2H(50)		
93	CL543-1028-4-51	DF3Z-2P-2V(51)	CL543-0357-0-51	DF3E-2P-2V(51)		
94	CL543-1029-7-51	DF3Z-3P-2V(51)	CL543-0358-0-51	DF3E-3P-2V(51)		
95	CL543-1030-6-51	DF3Z-4P-2V(51)	CL543-0359-0-51	DF3E-4P-2V(51)		
96	CL543-1031-9-51	DF3Z-5P-2V(51)	CL543-0360-0-51	DF3E-5P-2V(51)		
97	CL543-1032-1-51	DF3Z-6P-2V(51)	CL543-0361-0-51	DF3E-6P-2V(51)		
98	CL543-1033-4-51	DF3Z-7P-2V(51)	CL543-0362-0-51	DF3E-7P-2V(51)		
99	CL543-1034-7-51	DF3Z-8P-2V(51)	CL543-0363-0-51	DF3E-8P-2V(51)		
100	CL543-1036-2-51	DF3Z-10P-2V(51)	CL543-0365-0-51	DF3E-10P-2V(51)		
101	CL543-1056-0-51	DF3DZ-2P-2V(51)	CL543-0315-0-51	DF3EA-2P-2V(51)		
102	CL543-1057-2-51	DF3DZ-3P-2V(51)	CL543-0316-0-51	DF3EA-3P-2V(51)		
103	CL543-1058-5-51	DF3DZ-4P-2V(51)	CL543-0317-0-51	DF3EA-4P-2V(51)		
104	CL543-1059-8-51	DF3DZ-6P-2V(51)	CL543-0318-0-51	DF3EA-6P-2V(51)		
105	CL543-1060-7-51	DF3DZ-6P-2V(51)	CL543-0319-0-51	DF3EA-6P-2V(51)		
106	CL543-1061-0-51	DF3DZ-7P-2V(51)	CL543-0320-0-51	DF3EA-7P-2V(51)		
107	CL543-1062-2-51	DF3DZ-8P-2V(51)	CL543-0321-0-51	DF3EA-8P-2V(51)		
108	CL543-1063-5-51	DF3DZ-9P-2V(51)	CL543-0322-0-51	DF3EA-9P-2V(51)		
109	CL543-1064-8-51	DF3DZ-10P-2V(51)	CL543-0323-0-51	DF3EA-10P-2V(51)		
110	CL543-1065-0-51	DF3DZ-11P-2V(51)	CL543-0324-0-51	DF3EA-11P-2V(51)		
111	CL543-1066-3-51	DF3DZ-12P-2V(51)	CL543-0325-0-51	DF3EA-12P-2V(51)		
112	CL543-1067-6-51	DF3DZ-13P-2V(51)	CL543-0326-0-51	DF3EA-13P-2V(51)		
113	CL543-1068-9-51	DF3DZ-14P-2V(51)	CL543-0327-0-51	DF3EA-14P-2V(51)		
114	CL543-1069-1-51	DF3DZ-15P-2V(51)	CL543-0328-0-51	DF3EA-15P-2V(51)		
115	CL543-1042-5-51	DF3Z-2P-2H(51)	CL543-0343-0-51	DF3E-2P-2H(51)		
116	CL543-1044-0-51	DF3Z-4P-2H(51)	CL543-0345-0-51	DF3E-4P-2H(51)		
117	CL543-1046-6-51	DF3Z-6P-2H(51)	CL543-0347-0-51	DF3E-6P-2H(51)		
118	CL543-1047-9-51	DF3Z-7P-2H(51)	CL543-0348-0-51	DF3E-7P-2H(51)		
119	CL543-1055-7-51	DF3Z-15P-2H(51)	CL543-0356-0-51	DF3E-15P-2H(51)		
120	CL543-1070-0-51	DF3DZ-2P-2H(51)	CL543-0329-0-51	DF3EA-2P-2H(51)		
121	CL543-1071-3-51	DF3DZ-3P-2H(51)	CL543-0330-0-51	DF3EA-3P-2H(51)		
122	CL543-1072-6-51	DF3DZ-4P-2H(51)	CL543-0331-0-51	DF3EA-4P-2H(51)		
123	CL543-1073-9-51	DF3DZ-5P-2H(51)	CL543-0332-0-51	DF3EA-5P-2H(51)		
124	CL543-1074-1-51	DF3DZ-6P-2H(51)	CL543-0333-0-51	DF3EA-6P-2H(51)		
125	CL543-1075-4-51	DF3DZ-7P-2H(51)	CL543-0334-0-51	DF3EA-7P-2H(51)		
126	CL543-1076-7-51	DF3DZ-8P-2H(51)	CL543-0335-0-51	DF3EA-8P-2H(51)		
127	CL543-1077-0-51	DF3DZ-9P-2H(51)	CL543-0336-0-51	DF3EA-9P-2H(51)		
128	CL543-1078-2-51	DF3DZ-10P-2H(51)	CL543-0337-0-51	DF3EA-10P-2H(51)		
129	CL543-1079-5-51	DF3DZ-11P-2H(51)	CL543-0338-0-51	DF3EA-11P-2H(51)		
130	CL543-1080-4-51	DF3DZ-12P-2H(51)	CL543-0339-0-51	DF3EA-12P-2H(51)		
131	CL543-1081-7-51	DF3DZ-13P-2H(51)	CL543-0340-0-51	DF3EA-13P-2H(51)		
132	CL543-1082-0-51	DF3DZ-14P-2H(51)	CL543-0341-0-51	DF3EA-14P-2H(51)		
133	CL543-1083-2-51	DF3DZ-15P-2H(51)	CL543-0342-0-51	DF3EA-15P-2H(51)		
134	CL543-1071-3-59	DF3DZ-3P-2H(59)	CL543-0330-0-59	DF3EA-3P-2H(59)	Gold plated Pin extraction Embossed tape packaging (moisture-proof)	Gold plated Pin extraction Embossed tape packaging
135	CL543-1030-6-72	DF3Z-4P-2V(72)	CL543-0359-0-72	DF3E-4P-2V(72)	Tin plated Absorption tape attached Embossed tape packaging (moisture-proof)	Tin plated Absorption tape attached Embossed tape packaging
136	CL543-1031-9-72	DF3Z-5P-2V(72)	CL543-0360-0-72	DF3E-5P-2V(72)		

Attachment 1. List of Names of Products Before and After the Change

No.	Names of Products Affected by the Change		Product Name after Change		Remarks	
	Product Code	Product Name	Product Code	Product Name	Specification before change	Specification after change
137	CL543-1056-0-73	DF3DZ-2P-2V(73)	CL543-0315-0-51	DF3EA-2P-2V(51)	Gold plated Labeled Embossed tape packaging (Aluminum moisture-proof packaging)	Gold plated Embossed tape packaging
138	CL543-1058-5-73	DF3DZ-4P-2V(73)	CL543-0317-0-51	DF3EA-4P-2V(51)		
139	CL543-1060-7-73	DF3DZ-6P-2V(73)	CL543-0319-0-51	DF3EA-6P-2V(51)		
140	CL543-1064-8-73	DF3DZ-10P-2V(73)	CL543-0323-0-51	DF3EA-10P-2V(51)		
141	CL543-1066-3-73	DF3DZ-12P-2V(73)	CL543-0325-0-51	DF3EA-12P-2V(51)		
142	CL543-1069-1-73	DF3DZ-15P-2V(73)	CL543-0328-0-51	DF3EA-15P-2V(51)		
143	CL543-1070-0-73	DF3DZ-2P-2H(73)	CL543-0329-0-51	DF3EA-2P-2H(51)		
144	CL543-1074-1-73	DF3DZ-6P-2H(73)	CL543-0333-0-51	DF3EA-6P-2H(51)	Tin plated Labeled Embossed tape packaging (Aluminum moisture-proof packaging)	Tin plated Embossed tape packaging
145	CL543-1042-5-74	DF3Z-2P-2H(74)	CL543-0343-0-21	DF3E-2P-2H(21)		
146	CL543-1043-8-74	DF3Z-3P-2H(74)	CL543-0344-0-21	DF3E-3P-2H(21)	Tin plated Embossed tape packaging (Aluminum moisture-proof packaging)	Tin plated Embossed tape packaging
147	CL543-1056-0-75	DF3DZ-2P-2V(75)	CL543-0315-0-21	DF3EA-2P-2V(21)		
148	CL543-1057-2-75	DF3DZ-3P-2V(75)	CL543-0316-0-21	DF3EA-3P-2V(21)		
149	CL543-1058-5-75	DF3DZ-4P-2V(75)	CL543-0317-0-21	DF3EA-4P-2V(21)		
150	CL543-1060-7-75	DF3DZ-6P-2V(75)	CL543-0319-0-21	DF3EA-6P-2V(21)		
151	CL543-1062-2-75	DF3DZ-8P-2V(75)	CL543-0321-0-21	DF3EA-8P-2V(21)		
152	CL543-1070-0-75	DF3DZ-2P-2H(75)	CL543-0329-0-21	DF3EA-2P-2H(21)		
153	CL543-1072-6-75	DF3DZ-4P-2H(75)	CL543-0331-0-21	DF3EA-4P-2H(21)	Gold plated Embossed tape packaging (Aluminum moisture-proof packaging)	Tin plated Embossed tape packaging
154	CL543-1074-1-75	DF3DZ-6P-2H(75)	CL543-0333-0-21	DF3EA-6P-2H(21)		
155	CL543-1076-7-75	DF3DZ-8P-2H(75)	CL543-0335-0-21	DF3EA-8P-2H(21)		
156	CL543-1056-0-76	DF3DZ-2P-2V(76)	CL543-0315-0-51	DF3EA-2P-2V(51)	Gold plated Embossed tape packaging (Aluminum moisture-proof packaging)	Gold plated Embossed tape packaging
157	CL543-1059-8-76	DF3DZ-5P-2V(76)	CL543-0318-0-51	DF3EA-5P-2V(51)		
158	CL543-1071-3-76	DF3DZ-3P-2H(76)	CL543-0330-0-51	DF3EA-3P-2H(51)		
159	CL543-1073-9-76	DF3DZ-5P-2H(76)	CL543-0332-0-51	DF3EA-5P-2H(51)		
160	CL543-1058-5-77	DF3DZ-4P-2V(77)	CL543-0317-0-77	DF3EA-4P-2V(77)	Thick gold plated Embossed tape packaging (moisture-proof)	Thick gold plated Embossed tape packaging
161	CL543-1044-0-78	DF3Z-4P-2H(78)	CL543-0345-0-78	DF3E-4P-2H(78)	Gold plated Labeled Embossed tape packaging (moisture-proof)	Gold plated Labeled Embossed tape packaging
162	CL543-1034-7-94	DF3Z-8P-2V(94)	CL543-0363-0-94	DF3E-8P-2V(94)	Tin plated Insertion/extraction force reinforced Embossed tape packaging (moisture-proof)	Tin plated Insertion/extraction force reinforced Embossed tape packaging
163	CL543-1062-2-94	DF3DZ-8P-2V(94)	CL543-0321-0-94	DF3EA-8P-2V(94)		
164	CL543-1076-7-94	DF3DZ-8P-2H(94)	CL543-0335-0-94	DF3EA-8P-2H(94)		
165	CL543-1062-2-95	DF3DZ-8P-2V(95)	CL543-0321-0-95	DF3EA-8P-2V(95)	Gold plated Insertion/extraction force reinforced Embossed tape packaging (moisture-proof)	Gold plated Insertion/extraction force reinforced Embossed tape packaging
166	CL536-0510-8-25	DF13-10DP-1.25V(25)	CL536-0566-0-25	DF13E-10DP-1.25V(25)	Tin-copper plated Magazine packaging	Tin-copper plated Magazine packaging
167	CL536-0515-1-25	DF13-20DP-1.25V(25)	CL536-0567-0-25	DF13E-20DP-1.25V(25)		
168	CL536-0605-2-25	DF13A-20DP-1.25V(25)	CL536-0571-0-25	DF13EA-20DP-1.25V(25)	Tin-copper plated Embossed tape packaging (moisture-proof)	Tin-copper plated Embossed tape packaging
169	CL536-0510-8-95	DF13-10DP-1.25V(95)	CL536-0566-0-21	DF13E-10DP-1.25V(21)		
170	CL536-0515-1-95	DF13-20DP-1.25V(95)	CL536-0567-0-21	DF13E-20DP-1.25V(21)		
171	CL536-0520-1-95	DF13-30DP-1.25V(95)	CL536-0568-0-21	DF13E-30DP-1.25V(21)		
172	CL536-0600-9-95	DF13A-10DP-1.25V(95)	CL536-0570-0-21	DF13EA-10DP-1.25V(21)		
173	CL536-0605-2-95	DF13A-20DP-1.25V(95)	CL536-0571-0-21	DF13EA-20DP-1.25V(21)		
174	CL536-0610-2-95	DF13A-30DP-1.25V(95)	CL536-0572-0-21	DF13EA-30DP-1.25V(21)		
175	CL536-0615-6-95	DF13A-40DP-1.25V(95)	CL536-0573-0-21	DF13EA-40DP-1.25V(21)		
176	CL536-0510-8-55	DF13-10DP-1.25V(55)	CL536-0566-0-55	DF13E-10DP-1.25V(55)	Gold plated Magazine packaging	Gold plated Magazine packaging
177	CL536-0515-1-55	DF13-20DP-1.25V(55)	CL536-0567-0-55	DF13E-20DP-1.25V(55)		
178	CL536-0520-1-55	DF13-30DP-1.25V(55)	CL536-0568-0-55	DF13E-30DP-1.25V(55)		
179	CL536-0525-5-55	DF13-40DP-1.25V(55)	CL536-0569-0-55	DF13E-40DP-1.25V(55)		
180	CL536-0600-9-55	DF13A-10DP-1.25V(55)	CL536-0570-0-55	DF13EA-10DP-1.25V(55)		
181	CL536-0605-2-55	DF13A-20DP-1.25V(55)	CL536-0571-0-55	DF13EA-20DP-1.25V(55)		
182	CL536-0610-2-55	DF13A-30DP-1.25V(55)	CL536-0572-0-55	DF13EA-30DP-1.25V(55)		
183	CL536-0615-6-55	DF13A-40DP-1.25V(55)	CL536-0573-0-55	DF13EA-40DP-1.25V(55)	Gold plated Embossed tape packaging (moisture-proof)	Gold plated Embossed tape packaging
184	CL536-0510-8-91	DF13-10DP-1.25V(91)	CL536-0566-0-51	DF13E-10DP-1.25V(51)		
185	CL536-0515-1-91	DF13-20DP-1.25V(91)	CL536-0567-0-51	DF13E-20DP-1.25V(51)		
186	CL536-0520-1-91	DF13-30DP-1.25V(91)	CL536-0568-0-51	DF13E-30DP-1.25V(51)		
187	CL536-0525-5-91	DF13-40DP-1.25V(91)	CL536-0569-0-51	DF13E-40DP-1.25V(51)		
188	CL536-0600-9-91	DF13A-10DP-1.25V(91)	CL536-0570-0-51	DF13EA-10DP-1.25V(51)		
189	CL536-0605-2-91	DF13A-20DP-1.25V(91)	CL536-0571-0-51	DF13EA-20DP-1.25V(51)		
190	CL536-0610-2-91	DF13A-30DP-1.25V(91)	CL536-0572-0-51	DF13EA-30DP-1.25V(51)	Thick gold plated Embossed tape packaging	Thick gold plated Embossed tape packaging
191	CL536-0615-6-91	DF13A-40DP-1.25V(91)	CL536-0573-0-51	DF13EA-40DP-1.25V(51)		
192	CL536-0520-1-82	DF13-30DP-1.25V(82)	CL536-0568-0-82	DF13E-30DP-1.25V(82)		
193	CL536-0525-5-82	DF13-40DP-1.25V(82)	CL536-0569-0-82	DF13E-40DP-1.25V(82)		
194	CL536-0610-2-82	DF13A-30DP-1.25V(82)	CL536-0572-0-82	DF13EA-30DP-1.25V(82)		
195	CL536-0615-6-82	DF13A-40DP-1.25V(82)	CL536-0573-0-82	DF13EA-40DP-1.25V(82)		
196	CL536-0600-9-82	DF13A-10DP-1.25V(82)	CL536-0570-0-82	DF13EA-10DP-1.25V(82)		
197	CL536-0605-2-82	DF13A-20DP-1.25V(82)	CL536-0571-0-82	DF13EA-20DP-1.25V(82)	Gold plated Plastic reel Embossed tape packaging (moisture-proof)	Gold plated Plastic reel Embossed tape packaging
198	CL536-0605-2-93	DF13A-20DP-1.25V(93)	CL536-0571-0-93	DF13EA-20DP-1.25V(93)		

■ Description of form change of DF3 series connectors

1. Addition of round shapes and wider opening will make housing's break-resistant property against load at the time of tilted insertion even.

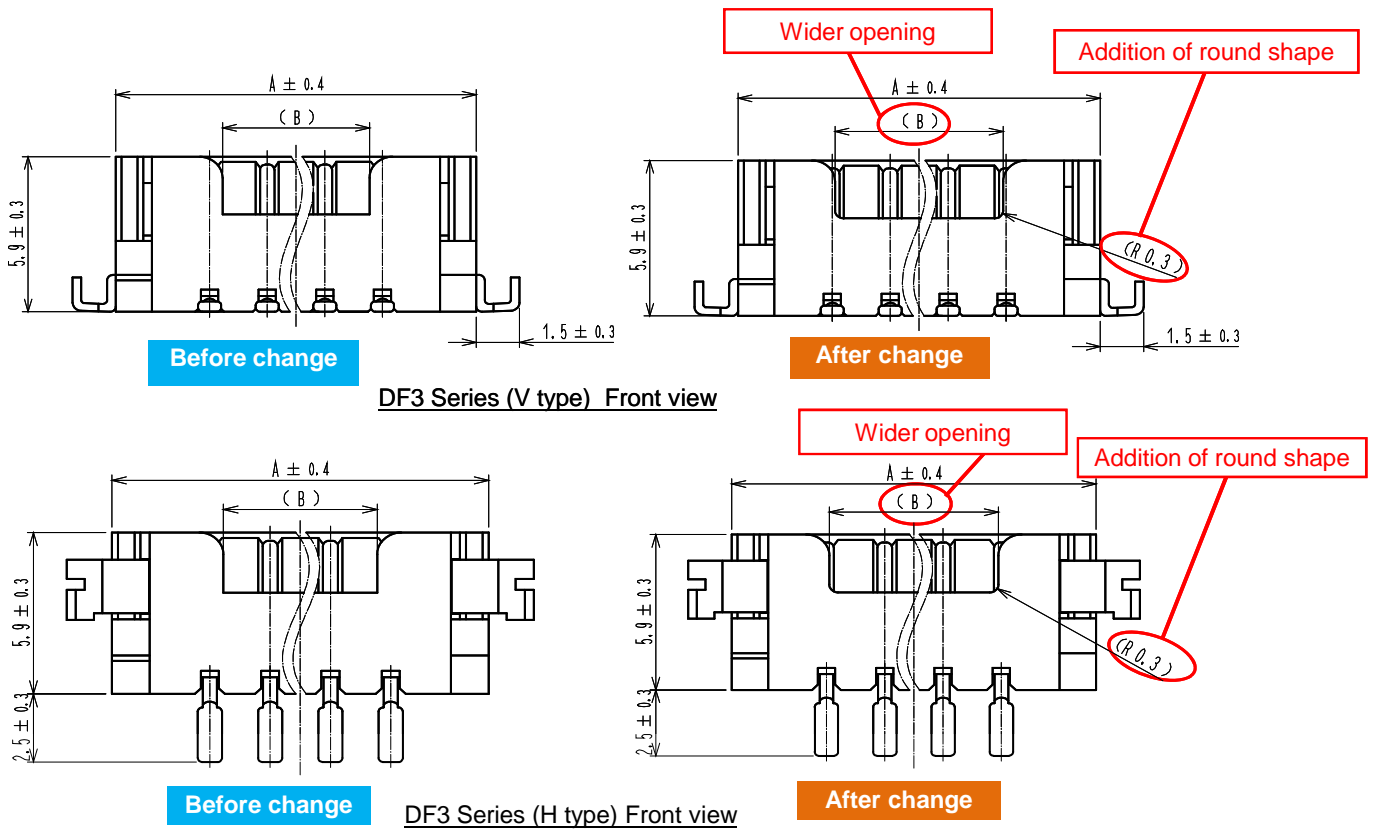

Unit: mm

# of pins	Before change		After change	
	Dimension A	Dimension B	Dimension A	Dimension B
2	6.5	1.05	6.5	1.75
3	8.5	3.05	8.5	3.75
4	10.5	5.05	10.5	5.75
5	12.5	7.05	12.5	7.75
6	14.5	9.05	14.5	9.75
7	16.5	11.05	16.5	11.75
8	18.5	13.05	18.5	13.75
9	20.5	15.05	20.5	15.75
10	22.5	17.05	22.5	17.75
11	24.5	19.05	24.5	19.75
12	26.5	21.05	26.5	21.75
13	28.5	23.05	28.5	23.75
14	30.5	25.05	30.5	25.75
15	32.5	27.05	32.5	27.75

2. We will achieve molding stability by adding lightening parts to make the thickness of the resin more even. There will be no change in the recommended PCB pattern drawing.

< DF3 Series (V type) >

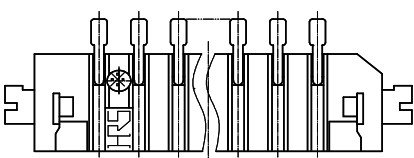
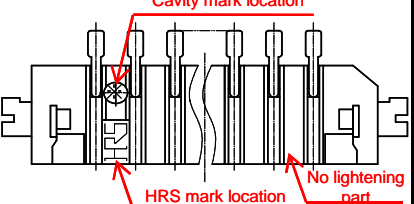
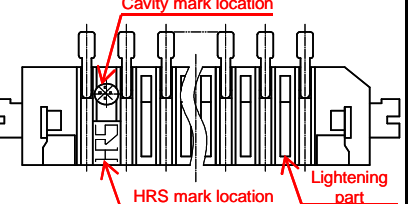
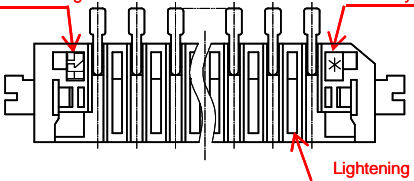
	2 to 6 pins	7 to 10 pins	11 to 15 pins
Before change	 DF3 Series (V type) bottom face	 Cavity mark location HRS mark location No lightening part	 Cavity mark location HRS mark location Lightening part
After change		 Lightening part HRS mark location change Lightening part Cavity mark location Lightening part	
Difference	No difference	<ul style="list-style-type: none"> • Lightening parts added • HRS/cavity mark location change 	<ul style="list-style-type: none"> • Lightening parts added • HRS/cavity mark location change

< DF3 series (H type) >

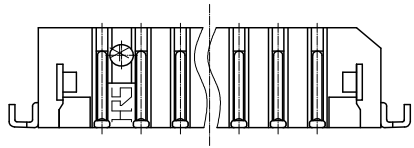
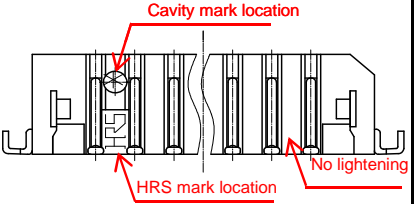
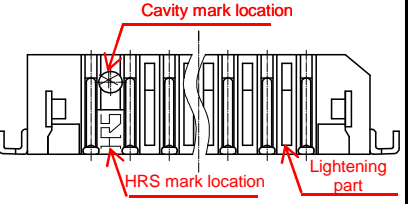
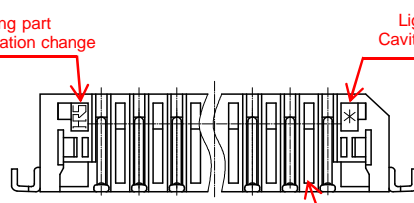
	2 to 6 pins	7 to 10 pins	11 to 15 pins
Before change	 DF3 series (H type) back face	 Cavity mark location HRS mark location No lightening	 Cavity mark location HRS mark location Lightening part
After change		 Lightening part HRS mark location change Lightening part Cavity mark location Lightening part	
Difference	No difference	<ul style="list-style-type: none"> • Lightening parts added • HRS/cavity mark location change 	<ul style="list-style-type: none"> • Lightening parts added • HRS/cavity mark location change

3. We will change the form of the lock to suppress the scraping of the lock at the time of extraction.

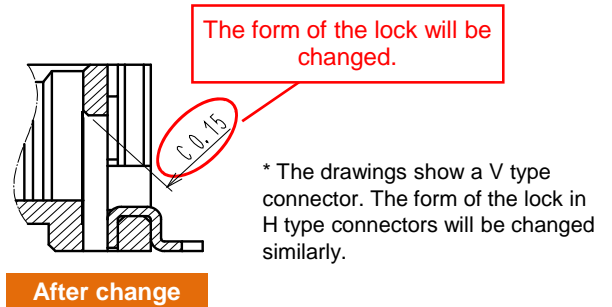
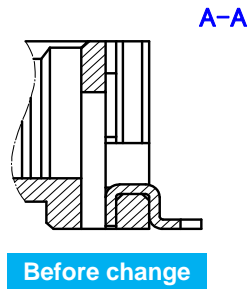
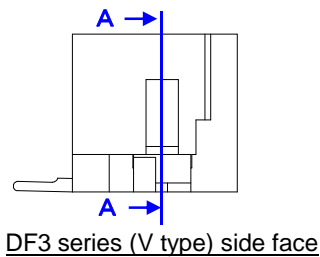

■ Description of form change in DF13 series connectors

- We will change the form of the lock to suppress the scraping of the lock at the time of extraction.

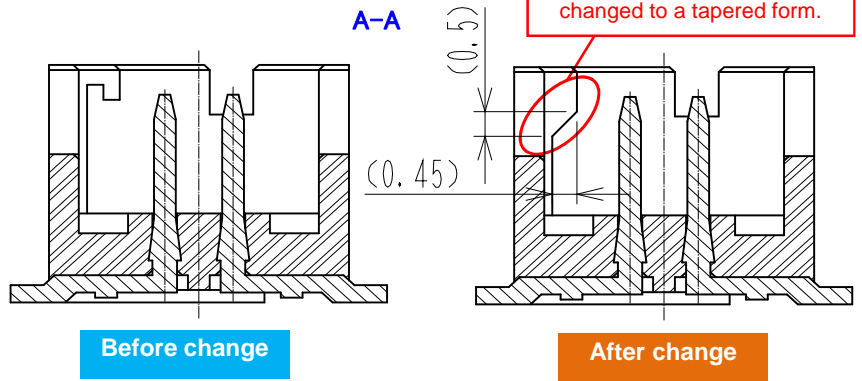
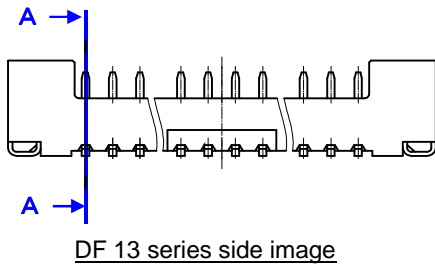

Acknowledgment

(Customer -> Hirose Electric business representative)

Notice of Change in Insulation Material (Polyamide Resin) for DF3 and DF13 Series Connectors and Request for Your Acknowledgement

We acknowledge the aforementioned matter.

- Customer's name: _____
- Acknowledgment stamp (or signature): _____

HIROSE ELECTRIC CO., LTD.

_____ (Cut on this line) _____

Document Receipt

(Customer -> Hirose Electric business representative)

Notice of Change in Insulation Material (Polyamide Resin) for DF3 and DF13 Series Connectors and Request for Your Acknowledgement

We received the document concerning the above.

- Customer's name: _____
- Acknowledgment stamp (or signature): _____

HIROSE ELECTRIC CO., LTD.