

### Features

- High collector-emitter breakdown voltage.  
( $V_{CE0} = 40V @ I_C = 10mA$ )
- Small load switch transistor with high gain and low saturation voltage, is designed for general purpose amplifier and switching applications at collector current.
- Capable of 225mW power dissipation.
- Lead-free parts for green partner, exceeds environmental standards of MIL-STD-19500 / 228
- Suffix "-H" indicates Halogen-free part, ex. MMBT2222-H.

### Mechanical data

- Epoxy: UL94-V0 rated flame retardant
- Case : Molded plastic, SOT-23
- Terminals : Solder plated, solderable per MIL-STD-750, Method 2026
- Mounting Position : Any

### Package outline

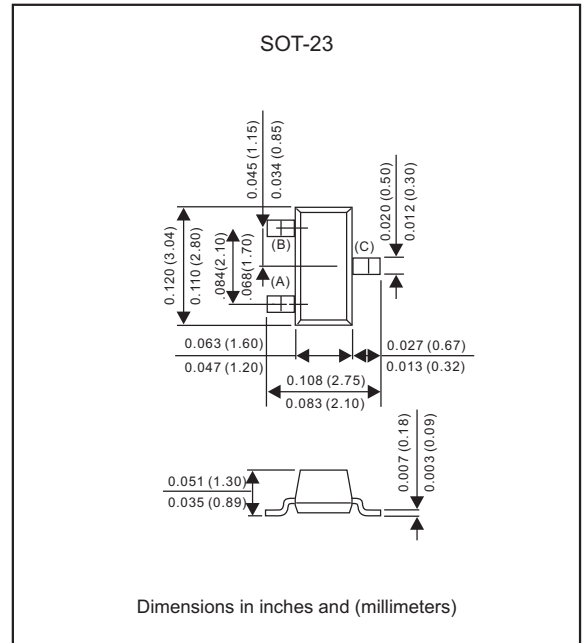

### Maximum ratings (AT $T_A = 25^\circ C$ unless otherwise noted)

PARAMETER	CONDITIONS	Symbol	MMBT2222	MMBT2222A	UNIT
Collector-base voltage		$V_{CBO}$	60	75	V
Collector-emitter voltage		$V_{CEO}$	30	40	V
Emitter-base voltage		$V_{EBO}$	5.0	6.0	V
Collector current		$I_C$	600		mA
Total device dissipation FR-5 board (1)	$T_A = 25^\circ C$	$P_D$	225		mW
	Derate above $25^\circ C$		1.8		mW/ $^\circ C$
Thermal resistance(1)	Junction to ambient	$R_{\theta JA}$	556		$^\circ C/W$
Total device dissipation alumina substrate(2)	$T_A = 25^\circ C$	$P_D$	300		mW
	Derate above $25^\circ C$		2.4		mW/ $^\circ C$
Thermal resistance(2)	Junction to ambient	$R_{\theta JA}$	417		$^\circ C/W$
Operating junction temperature range		$T_J$	-55 to +150		$^\circ C$
Storage temperature range		$T_{STG}$	-55 to +150		$^\circ C$

1. FR-5 = 1.0 X 0.75 X 0.062 in.

2. Alumina = 0.4 X 0.3 X 0.024 in. 99.5% alumina.

### ELECTRICAL CHARACTERISTICS (TA = 25°C unless otherwise noted)

Characteristics	Symbol	Min	Max	Unit	
<b>OFF CHARACTERISTICS</b>					
Collector-Emitter Breakdown Voltage (IC=10 mAdc, IB=0)	MMBT2222 MMBT2222A	V(BR)CEO	30 40	- -	Vdc
Collector-Base Breakdown Voltage (IC=10 µAdc, IE=0)	MMBT2222 MMBT2222A	V(BR)CBO	60 75	- -	Vdc
Emitter-Base Breakdown Voltage (IE=10 µAdc, IC=0)	MMBT2222 MMBT2222A	V(BR)EBO	5.0 6.0	- -	Vdc
Collector Cutoff Current (VCE=60 Vdc, VEB (off)=3.0 Vdc)	MMBT2222A	ICEX	-	10	nAdc
Collector Cutoff Current (VCB=50 Vdc, IE=0)	MMBT2222	ICBO	-	0.01	µAdc
(VCB=60Vdc, IE=0)	MMBT2222A		-	0.01	
(VCB=50Vdc, IE=0, TA=125 °C)	MMBT2222		-	10	
(VCB=60Vdc, IE=0, TA=125 °C)	MMBT2222A		-	10	
Emitter Cutoff Current (VEB=3.0 Vdc, IC=0)	MMBT2222A	IEBO	-	100	nAdc
Base Cutoff Current (VCE=60Vdc, VEB(off)=3.0Vdc)	MMBT2222A	IBL	-	20	nAdc

### ELECTRICAL CHARACTERISTICS (TA = 25°C unless otherwise noted) (Continued)

Characteristics	Symbol	Min	Max	Unit	
<b>ON CHARACTERISTICS</b>					
DC Current Gain	hFE	35 50 75 35 100 50 30 40	- - - - 300 - - -	-	
(IC=0.1 mAdc, VCE=10 Vdc)					
(IC=1.0 mAdc, VCE=10 Vdc)					
(IC=10 mAdc, VCE=10 Vdc)					
(IC=10 mAdc, VCE=10 Vdc, TA=-55°C)					MMBT2222A ONLY
(IC=150 mAdc, VCE=10 Vdc) (3)					
(IC=150 mAdc, VCE=1.0Vdc) (3)					
(IC=500 mAdc, VCE=10 Vdc) (3)	MMBT2222 MMBT2222A				
Collector-Emitter Saturation Voltage (3)	VCE(sat)	- - - -	0.4 0.3 1.6 1.0	Vdc	
(IC=150 mAdc, IB=15mAdc)					MMBT2222 MMBT2222A
(IC=500 mAdc, IB=50mAdc)					MMBT2222 MMBT2222A
Base-Emitter Saturation Voltage (3)	VBE(sat)	- 0.6 - -	1.3 1.2 2.6 2.0	Vdc	
(IC=150 mAdc, IB=15mAdc)					MMBT2222 MMBT2222A
(IC=500 mAdc, IB=50mAdc)					MMBT2222 MMBT2222A

### ELECTRICAL CHARACTERISTICS (T<sub>A</sub> = 25°C unless otherwise noted) (Continued)

Characteristics	Symbol	Min	Max	Unit
<b>SMALL-SIGNAL CHARACTERISTICS</b>				
Current-Gain-Bandwidth Product (4) (I <sub>C</sub> =20 mA, V <sub>CE</sub> =20 Vdc, f=100MHz)	MMBT2222 MMBT2222A f <sub>T</sub>	250 300	- -	MHz
Output Capacitance (V <sub>CB</sub> =10 Vdc, I <sub>E</sub> =0, f=1.0MHz)	MMBT2222 MMBT2222A C <sub>obo</sub>	-	8.0	pF
Input Capacitance (V <sub>EB</sub> =0.5 Vdc, I <sub>C</sub> =0, f=1.0MHz)	MMBT2222 MMBT2222A C <sub>ibo</sub>	- -	30 25	pF
Input Impedance (I <sub>C</sub> =1.0 mA, V <sub>CE</sub> =10 Vdc, f=1.0 kHz) (I <sub>C</sub> =10 mA, V <sub>CE</sub> =10 Vdc, f=1.0 kHz)	MMBT2222A MMBT2222A h <sub>ie</sub>	2.0 0.25	8.0 1.25	κΩ
Voltage Feedback Ratio (I <sub>C</sub> =1.0 mA, V <sub>CE</sub> =10 Vdc, f=1.0 kHz) (I <sub>C</sub> =10 mA, V <sub>CE</sub> =10 Vdc, f=1.0 kHz)	MMBT2222A MMBT2222A h <sub>re</sub>	- -	8.0 4.0	x 10 <sup>-4</sup>
Small-Signal Current Gain (I <sub>C</sub> =1.0 mA, V <sub>CE</sub> =10Vdc, f=1.0 kHz) (I <sub>C</sub> =10 mA, V <sub>CE</sub> =10Vdc, f=1.0 kHz)	MMBT2222A MMBT2222A h <sub>fe</sub>	50 75	300 375	-
Output Admittance (I <sub>C</sub> =1.0 mA, V <sub>CE</sub> =10Vdc, f=-1.0kHz) (I <sub>C</sub> =10 mA, V <sub>CE</sub> =10Vdc, f=-1.0kHz)	MMBT2222A MMBT2222A h <sub>oe</sub>	5.0 25	35 200	μmhos
Collector Base Time Constant (I <sub>E</sub> =20 mA, V <sub>CB</sub> =20 Vdc, f=31.8 MHz)	MMBT2222A r <sub>b</sub> , C <sub>C</sub>	-	150	ps
Noise Figure (I <sub>C</sub> =100μA, V <sub>CE</sub> =10Vdc, R <sub>S</sub> =1.0kΩ, f=1.0 kHz)	MMBT2222A NF	-	4.0	dB

### SWITCHING CHARACTERISTICS (MMBT2222A only)

Delay Time	(V <sub>CC</sub> =30 Vdc, V <sub>BE</sub> (off)=-0.5Vdc, I <sub>C</sub> =150 mA, I <sub>B1</sub> =15 mA)	t <sub>d</sub>	-	10	ns
Rise Time		t <sub>r</sub>	-	25	
Storage Time	(V <sub>CC</sub> =30 Vdc, I <sub>C</sub> =150 mA, I <sub>B1</sub> =I <sub>B2</sub> =15 mA)	t <sub>s</sub>	-	225	ns
Fall Time		t <sub>f</sub>	-	60	

3. Pulse Test: Pulse Width 300 μs, Duty Cycle ≤ 2.0%.

4. f<sub>T</sub> is defined as the frequency at which I<sub>hfe</sub> extrapolates to unity.

### Rating and characteristic curves (MMBT2222 / MMBT2222A)

**Typical Pulsed Current Gain vs Collector Current**

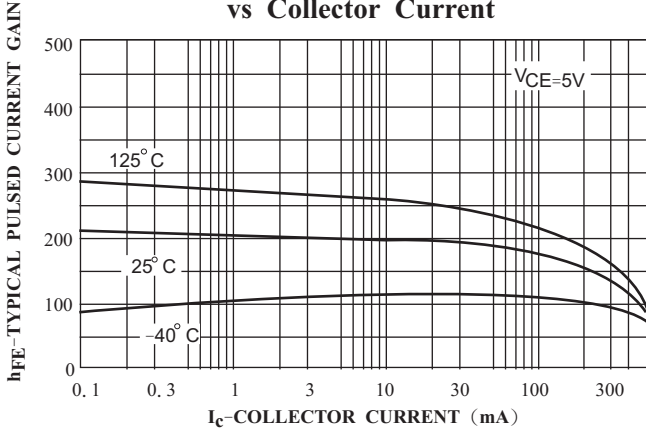

**Collector- Emitter Saturation Voltage vs Collector Current**

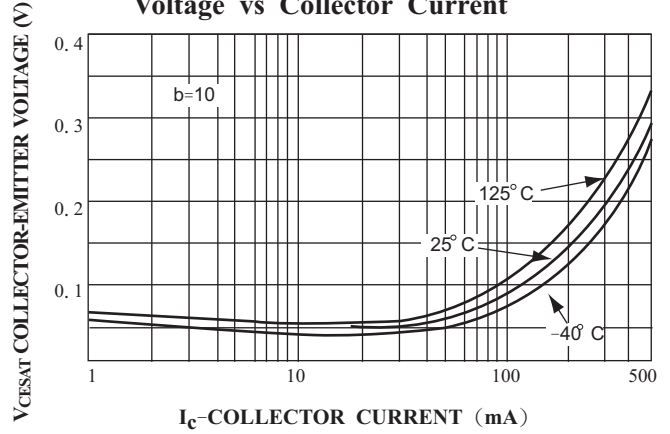

**Base- Emitter Saturation Voltage vs Collector Current**

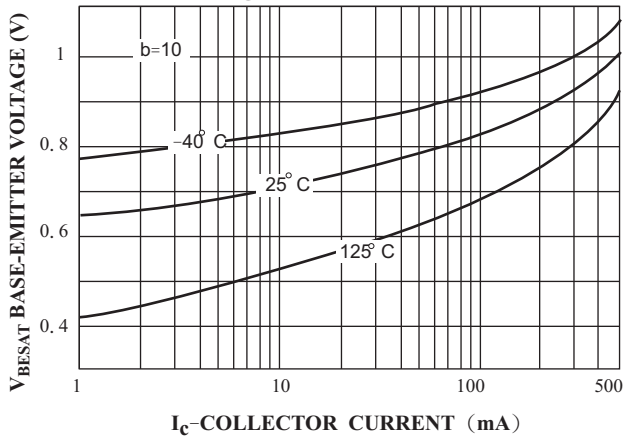

**Base- Emitter ON Voltage vs Collector Current**

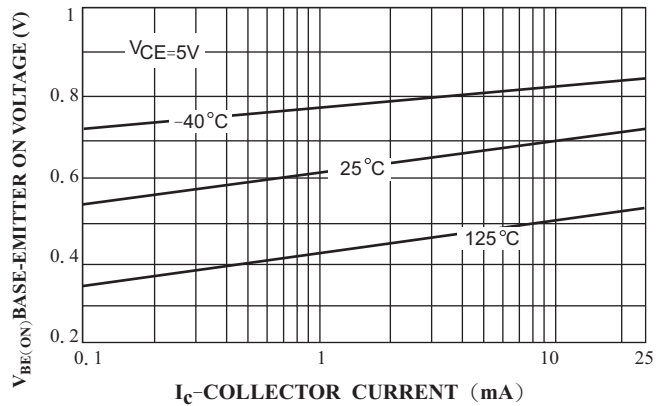

**Collector- Cutoff Current vs Ambient Temperature**

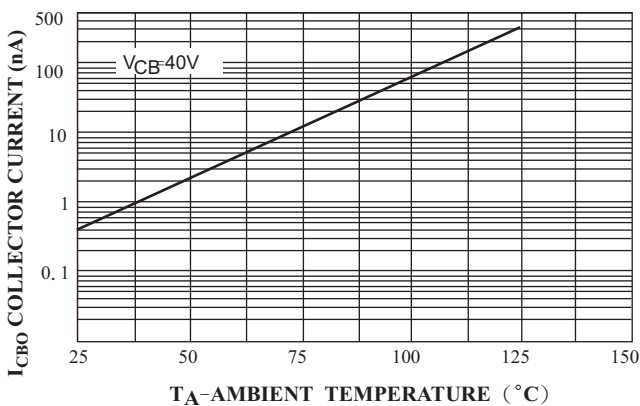

**Emitter Transition and Output Capacitance vs Reverse Bias Voltage**

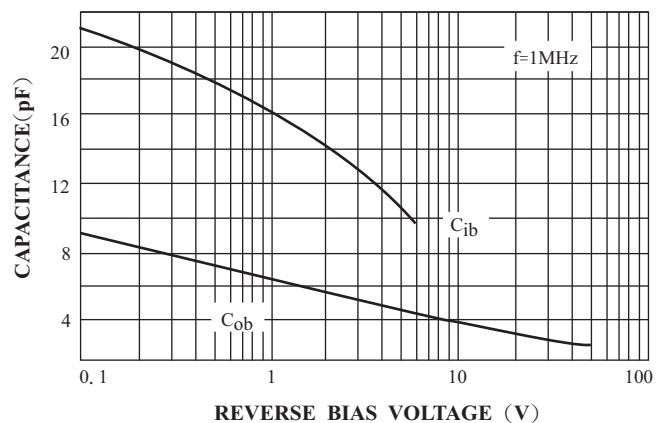

### Rating and characteristic curves (MMBT2222 / MMBT2222A)

**Turn On and Turn Off Times vs Collector Current**

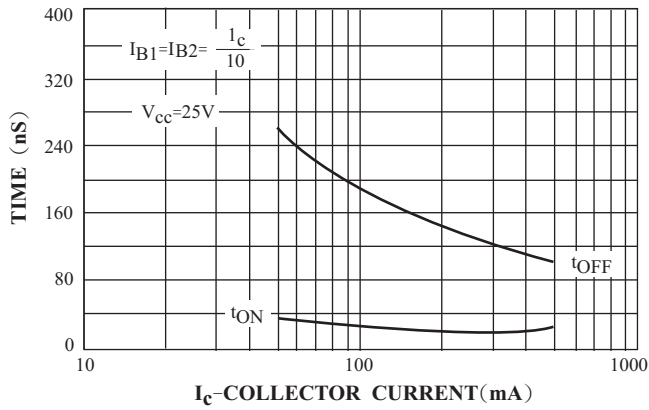

**Switching Times vs Collector Current**

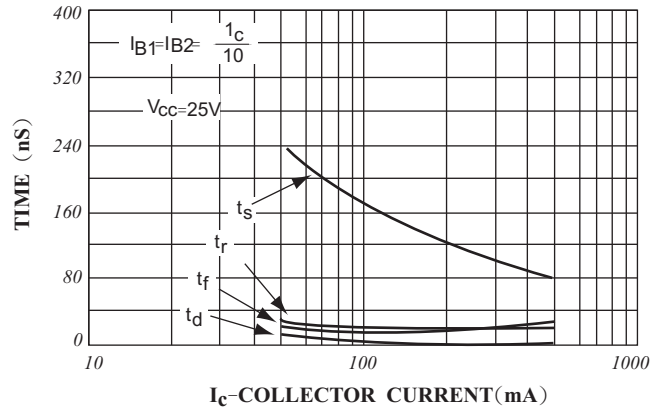

**Power Dissipation vs Ambient Temperature**

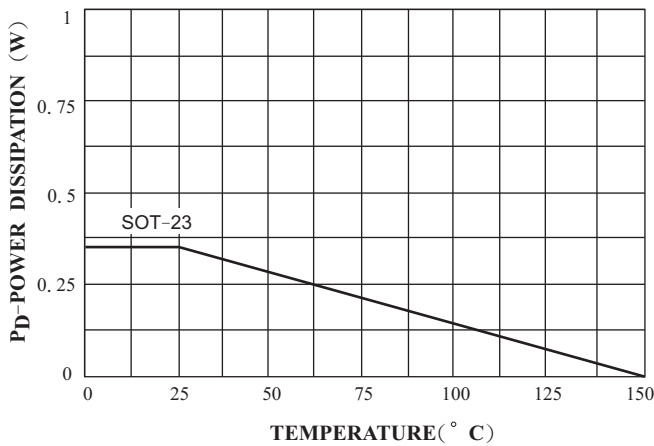

**TEST CIRCUIT**

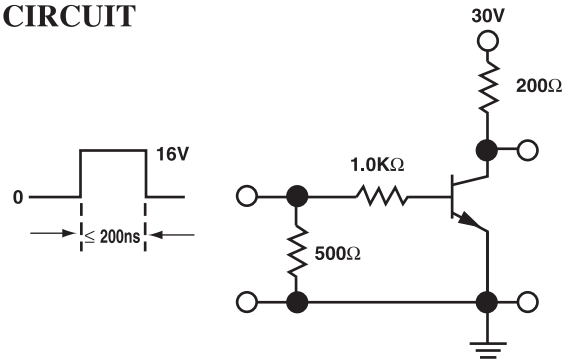

**FIGURT 1: Saturated Turn-On Switching Time**

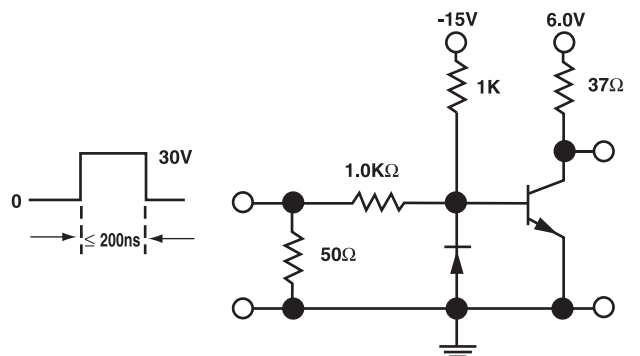

**FIGURT 2: Saturated Turn-Off Switching Time**

### Pinning information

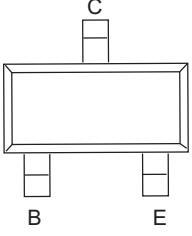
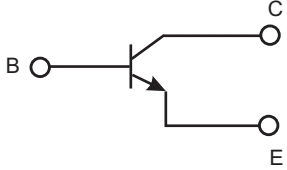
Pin	Simplified outline	Symbol
PinB Base PinC Collector PinE Emitter		

### Marking

Type number	Marking code
MMBT2222	M1B
MMBT2222A	1P

### Suggested solder pad layout

#### SOT-23

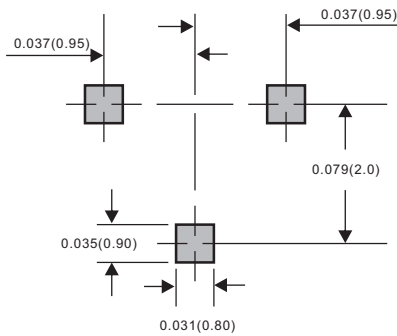

Dimensions in inches and (millimeters)