



Mini-Circuits

SURFACE MOUNT ^{top hat}

Directional Coupler

TCD-12-222X+

50Ω

5 to 2250 MHz

THE BIG DEAL

- Wideband, 5 to 2250 MHz
- Low mainline loss, 2.0 dB typ.
- Aqueous washable
- Leads for excellent solderability
- Protected by US Patent 6,140,887

APPLICATIONS

- VHF/UHF
- CATV
- Cellular



Generic photo used for illustration purposes only

CASE STYLE: DB1627

+RoHS Compliant

The +Suffix identifies RoHS Compliance. See our website for methodologies and qualifications

PRODUCT OVERVIEW

Mini-Circuits' TCD-12-222X+ surface mount directional coupler provides 12.6 dB nominal coupling with excellent flatness from 5 to 2250 MHz, supporting a wide variety of applications including VHF/UHF, CATV, cellular and more. This model provides low mainline loss, high directivity and excellent return loss. The coupler is built with core and wire construction mounted on a 6-lead plastic base (0.16 x 0.15 x 0.16") and includes Mini-Circuits' TopHat® feature for faster, more accurate pick-and-place assembly.

KEY FEATURES

Feature	Advantages
Low mainline loss, 2.0 dB	Provides good through-path signal power transmission.
High directivity, 10 – 21 dB	High directivity allows accurate signal sampling through the coupled port with minimal measurement error.
Excellent return loss, 14 – 25 dB (input/output/coupling)	Provides excellent matching for 50Ω systems and minimal signal reflection.
1W power handling	Usable in systems with a variety of high-power requirements.
Top Hat® feature	Improves speed and accuracy of pick and place assembly and provides clear device marking for visual inspection.





ELECTRICAL SPECIFICATIONS AT 25°C

Parameter	Frequency (MHz)	Min.	Typ.	Max.	Unit
Frequency Range	—	5	—	2250	MHz
Mainline Loss ¹ (above theoretical 0.3 dB)	5	—	0.4	1.0	dB
	950	—	0.6	1.1	
	2250	—	2.5	3.5	
Coupling	5-2250	—	12.6±0.8	—	
Coupling Flatness (±)	5-2250	—	0.6	1.0	
Directivity	5	17	21	—	dB
	950	11	15	—	
	2250	6	10	—	
Return Loss (Input)	5	—	21	—	dB
	950	—	17	—	
	2250	—	16	—	
Return Loss (Output)	5	—	25	—	dB
	950	—	17	—	
	2250	—	14	—	
Return Loss (Coupling)	5	—	24	—	dB
	950	—	17	—	
	2250	—	15	—	
Input Power	5-100	—	—	0.5	W
	100-2250	—	—	1.0	

1. Mainline loss includes theoretical power loss 0.3 dB at coupled port.

MAXIMUM RATINGS

Parameter	Ratings
Operating Temperature	-40°C to 85°C*
Storage Temperature	-55°C to 100°C

Permanent damage may occur if any of these limits are exceeded.

* Case temperature is defined as temperature on ground leads.

ELECTRICAL SCHEMATIC

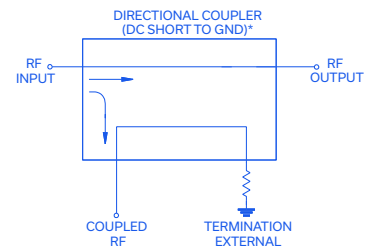

*Electrical schematic is for Directional coupler with internal transformer(s) and external termination



Mini-Circuits

SURFACE MOUNT ^{top hat}

Directional Coupler

TCD-12-222X+

50Ω

5 to 2250 MHz

PIN CONNECTIONS

INPUT	3
OUTPUT	4
COUPLED	1
GROUND	2
50Ω TERM EXTERNAL	6
NOT USED	5

PRODUCT MARKING: DA

DEMO BOARD MCL P/N: TB-71
SUGGESTED PCB LAYOUT (PL-009)

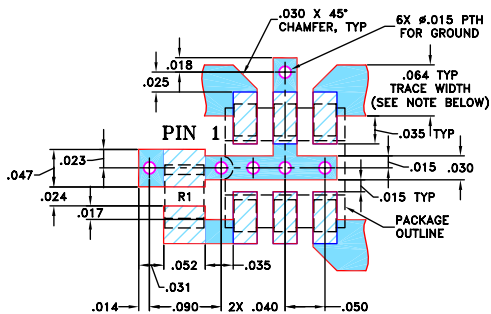

RESISTOR R1: 49.9 ± 1% Ohm, 0805 SIZE

NOTES: 1. TRACE WIDTH IS SHOWN FOR ROGERS RO4350B WITH DIELECTRIC THICKNESS 0.030" ± 0.002"; COPPER: 1/2 OZ. EACH SIDE. FOR OTHER MATERIALS TRACE WIDTH MAY NEED TO BE MODIFIED.

2. BOTTOM SIDE OF THE PCB IS CONTINUOUS GROUND PLANE.

- DENOTES PCB COPPER LAYOUT WITH SMOBC (SOLDER MASK OVER BARE COPPER)
- DENOTES COPPER LAND PATTERN FREE OF SOLDER MASK

OUTLINE DRAWING

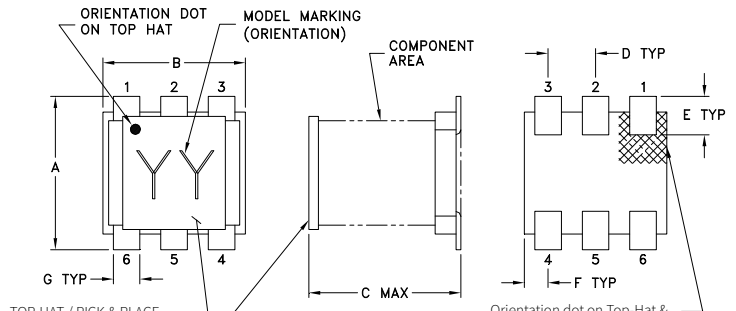

TOP-HAT / PICK & PLACE SURFACE AREA (L10X10) MIN
TOP-HAT TOTAL THICKNESS: .013 inches MAX.

PCB Land Pattern

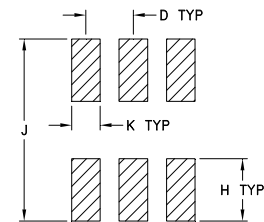

SUGGESTED LAYOUT TOLERANCE TO BE WITHIN ±.002

OUTLINE DIMENSIONS (Inches mm)

A	B	C	D	E	F
.160	.150	.160	.050	.040	.025
4.06	3.81	4.06	1.27	1.02	0.64
G	H	J	K		wt
.028	.065	.190	.030		grams
0.71	1.65	4.83	0.76		0.15

TAPE & REEL INFORMATION: F47



Directional Coupler

TCD-12-222X+

TYPICAL PERFORMANCE DATA

Frequency (MHz)	Mainline Loss (dB)		Coupling (dB)	Directivity (dB)	Return Loss (dB)		
	In-Out	In-Cpl			In	Out	Cpl
5	0.68	12.93	21.57	22.32	29.51	24.61	
50	0.67	12.93	21.29	23.52	32.47	25.50	
150	0.69	12.95	21.07	23.03	28.80	24.43	
450	0.79	12.91	18.41	19.74	21.23	20.14	
750	0.97	12.76	15.89	17.36	18.25	17.65	
950	1.11	12.59	14.35	16.58	17.20	16.83	
1350	1.51	12.09	12.29	16.52	15.97	16.81	
1650	1.96	11.72	11.78	18.33	15.47	17.99	
1950	2.61	11.66	12.08	23.10	14.97	19.94	
2250	3.36	12.35	12.80	28.39	14.69	21.95	

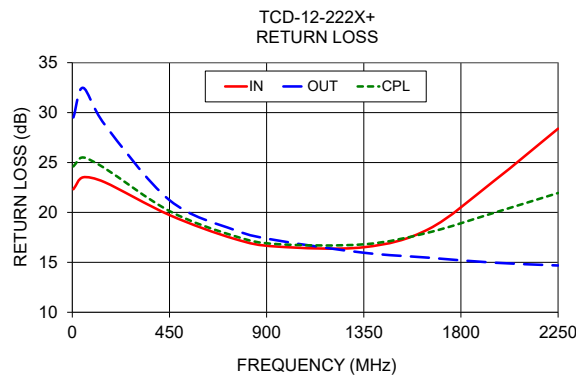
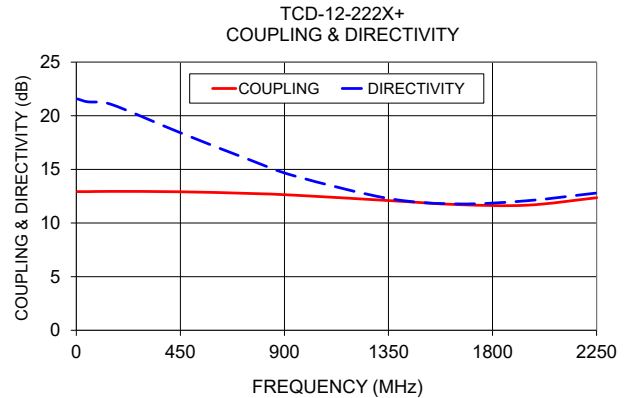
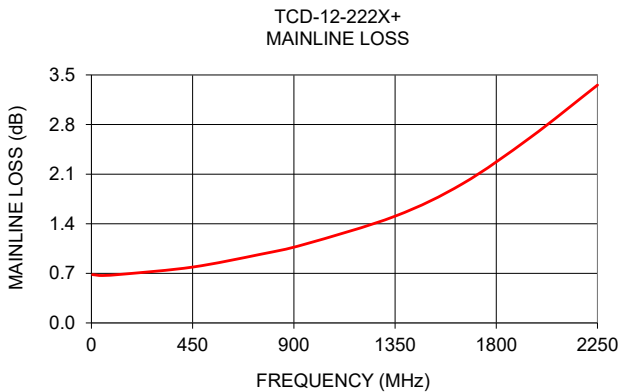

- NOTES**
- A. Performance and quality attributes and conditions not expressly stated in this specification document are intended to be excluded and do not form a part of this specification document.
 - B. Electrical specifications and performance data contained in this specification document are based on Mini-Circuit's applicable established test performance criteria and measurement instructions.
 - C. The parts covered by this specification document are subject to Mini-Circuits standard limited warranty and terms and conditions (collectively, "Standard Terms"); Purchasers of this part are entitled to the rights and benefits contained therein. For a full statement of the standard. Terms and the exclusive rights and remedies thereunder, please visit Mini-Circuits' website at www.minicircuits.com/terms/viewterm.html