

# Mini Half-Watt SMD 3.5mm (120° Viewing Angle)



## OVS5MxBCR4 Series

### Features:

- Compact Package Outline of 3.5 x 3.5 x 1.2 mm
- Robust energy-efficient design with long operating life
- Low thermal resistance
- Exceptional spatial uniformity
- Compatible to IR reflow soldering
- High Lumens output



### Description:

The mini-half watt is an energy-efficient packaged LED source that offers high luminance, and a long operating lifespan. This device offers a 120° viewing angle and an ultra-low profile (1.2 mm) making it highly suitable for conventional lighting and specialized applications.

### Applications:

- Automotive exterior and interior lighting
- Architectural indoor and outdoor lighting
- General lighting
- Display Backlighting
- Electronic signs and signals

Part Number	Viewing Angle	Emitted Color	Typ. Luminous Flux (lm)	Forward Voltage $V_F$	Power Dissipation @ 150 mA	Lens Color
OVS5MWBCR4	120	White	50	3.4	0.51 W	Clear
OVS5MWWBCR4		Warm White	30	3.6	0.54 W	
OVS5MBBCR4		Blue	8.2	3.4	0.51 W	
OVS5MGBCR4		Green	22	3.4	0.51 W	

Part Number	Viewing Angle	Emitted Color	Typ. Luminous Intensity (mcd)	Forward Voltage $V_F$	Power Dissipation @ 150 mA	Lens Color
OVS5MRBCR4	120	Red	7150	2.2	0.33 W	Clear
OVS5MABCR4		Amber	7150	2.2	0.33 W	
OVS5MYBCR4		Yellow	7150	2.2	0.33 W	



**DO NOT LOOK DIRECTLY AT LED WITH UNSHIELDED EYES OR DAMAGE TO RETINA MAY**

### General Note

TT Electronics reserves the right to make changes in product specification without notice or liability. All information is subject to TT Electronics' own data and is considered accurate at time of going to print.

TT Electronics | OPTEK Technology  
1645 Wallace Drive, Carrollton, TX 75006 | Ph: +1 972 323 2200  
www.ttelectronics.com | www.optekinc.com

# Mini Half-Watt SMD 3.5mm (120° Viewing Angle)



## OVS5MxBCR4 Series

### Electrical Specifications

Absolute Maximum Ratings (T <sub>A</sub> = 25° C unless otherwise noted)				
	Red, Amber, Yellow	Green, Blue	White	Warm White
DC Forward Current	200 mA a	180 mA	180 mA	180 mA
Peak Pulsed Forward Current <sup>1</sup>	1000 mA	350 mA	350 mA	350 mA
Reverse Voltage	12V @ 10 uA	Not designed for reverse bias	Not designed for reverse bias	Not designed for reverse bias
Junction Temperature <sup>2</sup>	125°C	125°C	125°C	125°C
Power Dissipation	750mW	750mW	750mW	750mW
Storage and Operating Temperature	-40° ~ +100 ° C	-40° ~ +100 ° C	-40° ~ +100 ° C	-40° ~ +100 ° C
ESD (JEDEC-JESD22-A114F)	Class 2	Class 2	Class 2	Class 2
MSL (IPC / JEDEC J-STD-020C)	2a / 672 Hrs	2a / 672 Hrs	2a / 672 Hrs	2a / 672 Hrs

**Notes:**

1. Pulse width  $t_p \leq 10\mu s$ , Duty cycle = 0.1
2. Thermal Resistance = 5 C/W

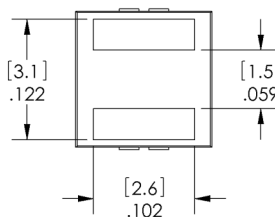
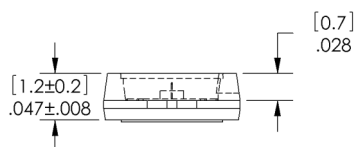
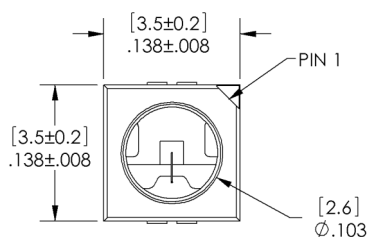

DIMENSIONS ARE IN INCHES [MM].

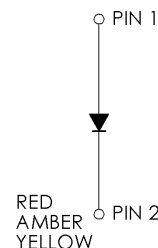
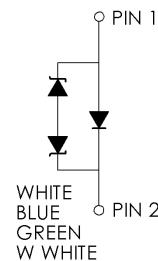
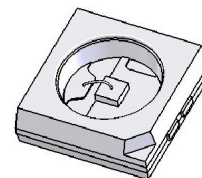

PIN 1	ANODE
PIN 2	CATHODE

**General Note**

TT Electronics reserves the right to make changes in product specification without notice or liability. All information is subject to TT Electronics' own data and is considered accurate at time of going to print.

TT Electronics | OPTEK Technology  
1645 Wallace Drive, Carrollton, TX 75006 | Ph: +1 972 323 2200  
www.ttelectronics.com | www.optekinc.com

# Mini Half-Watt SMD 3.5mm (120° Viewing Angle)



## OVS5MxBCR4 Series

### Optical and Electrical Characteristics - Red, Amber, Yellow ( $I_F = 140 \text{ mA}$ , $T_A = 25^\circ \text{ C}$ )

SYMBOL	PARAMETER	MIN	TYP	MAX	UNITS	
$V_F$	Forward Voltage	1.9	2.2	2.65	V	
$\Phi$	Luminous Intensity	Red	4500	7150	9000	mcd
		Amber				
		Yellow				
$\lambda_D$	Dominant Wavelength	Red	620	625	630	nm
		Amber	610	615	621	
		Yellow	585	590	594	
$I_R$	Reverse Current @ 12 V	----	10	----	$\mu\text{A}$	
$2\theta_{\frac{1}{2}}$	50% Power Angle	----	120	----	deg	

### Optical and Electrical Characteristics - Blue, Green ( $I_F = 150 \text{ mA}$ , $T_A = 25^\circ \text{ C}$ )

SYMBOL	PARAMETER	MIN	TYP	MAX	UNITS	
$V_F$	Forward Voltage	3.0	3.4	3.9	V	
$\Phi$	Luminous Flux	Blue	6.3	8.2	10.7	lm
		Green	18.1	22.0	30.6	
$\lambda_D$	Dominant Wavelength	Blue	460	465	470	nm
		Green	520	525	535	
$2\theta_{\frac{1}{2}}$	50% Power Angle	----	120	----	deg	

### Optical and Electrical Characteristics - White, Warm White ( $I_F = 150 \text{ mA}$ , $T_A = 25^\circ \text{ C}$ )

SYMBOL	PARAMETER	MIN	TYP	MAX	UNITS	
$V_F$	Forward Voltage	White	3.0	3.4	4.1	V
		Warm White		3.6		
$\Phi$	Luminous Flux	White	30.6	50	67.2	lm
		Warm White	23.5	30	39.8	
$2\theta_{\frac{1}{2}}$	50% Power Angle	----	120	----	deg	

#### General Note

TT Electronics reserves the right to make changes in product specification without notice or liability. All information is subject to TT Electronics' own data and is considered accurate at time of going to print.

TT Electronics | OPTEK Technology  
1645 Wallace Drive, Carrollton, TX 75006 | Ph: +1 972 323 2200  
www.ttelectronics.com | www.optekinc.com

# Mini Half-Watt SMD 3.5mm (120° Viewing Angle)



## OVS5MxBCR4 Series

OVS5MABCR4 (Amber), OVS5MRBCR4 (Red) and OVS5MYBCR4 (Yellow)

Relative Intensity Vs Forward Current

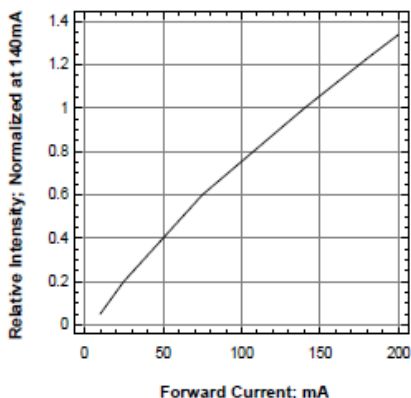

Forward Voltage Vs Forward Current

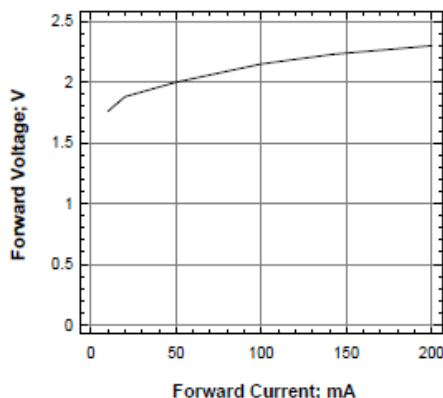

Maximum Current Vs Ambient Temperature

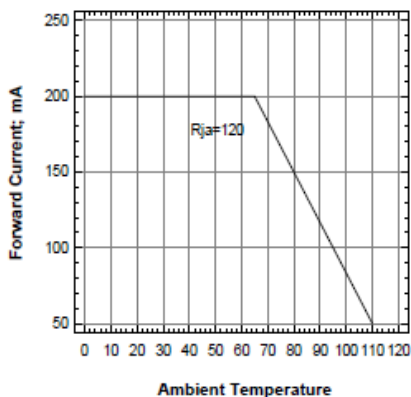

Maximum Current vs Solder-Point Temperature

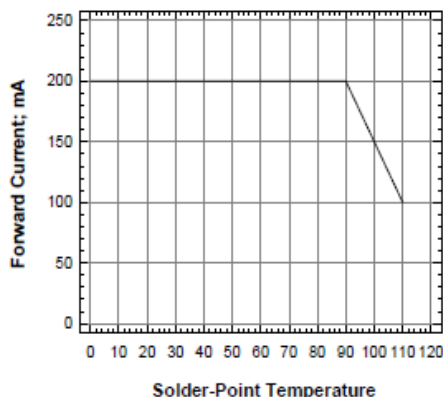

Relative Intensity Vs Wavelength

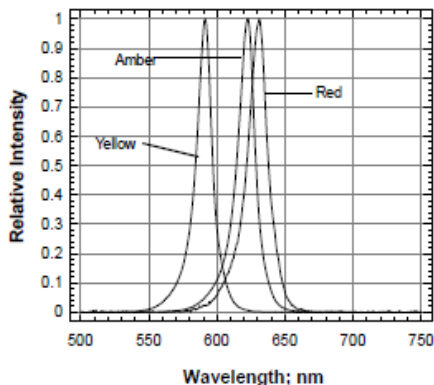

Allowable Forward Current Vs Duty Ratio

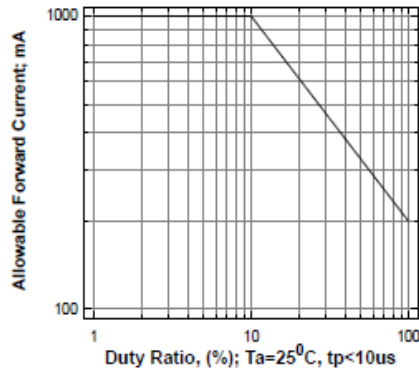

General Note

TT Electronics reserves the right to make changes in product specification without notice or liability. All information is subject to TT Electronics' own data and is considered accurate at time of going to print.

TT Electronics | OPTEK Technology  
1645 Wallace Drive, Carrollton, TX 75006 | Ph: +1 972 323 2200  
www.ttelectronics.com | www.optekinc.com

# Mini Half-Watt SMD 3.5mm (120° Viewing Angle)



## OVS5MxBRC4 Series

OVS5MBCR4 (Blue), OVS5MGBCR4 (Green), OVS5MWBCR4 (White) and OVS5MWWBCR4 (Warm White)

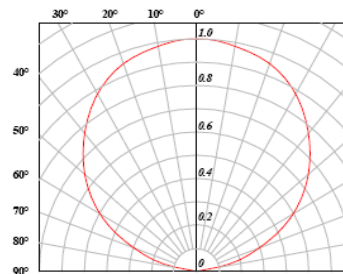
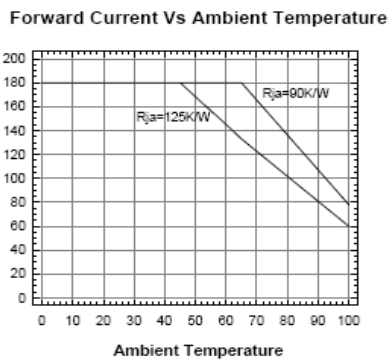
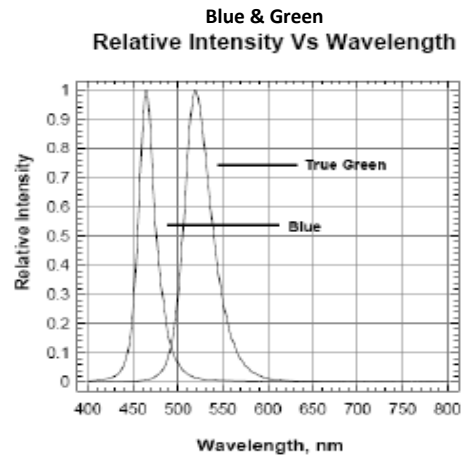
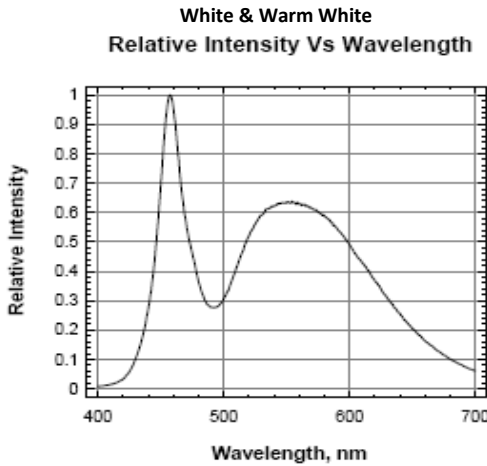
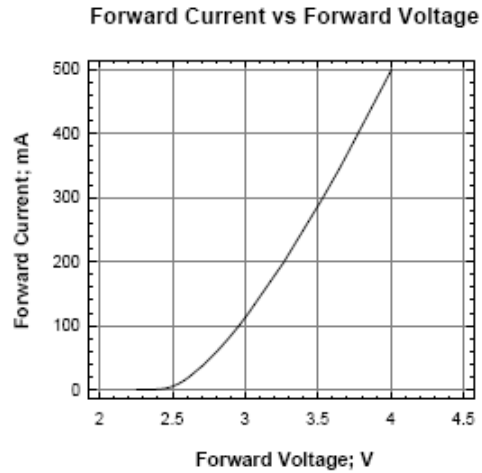
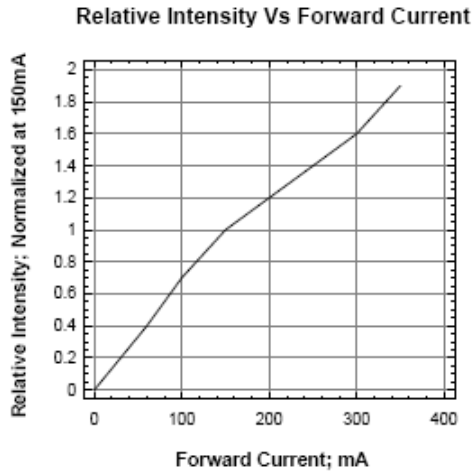

**General Note**

TT Electronics reserves the right to make changes in product specification without notice or liability. All information is subject to TT Electronics' own data and is considered accurate at time of going to print.

TT Electronics | OPTEK Technology  
1645 Wallace Drive, Carrollton, TX 75006 | Ph: +1 972 323 2200  
www.ttelectronics.com | www.optekinc.com

# Mini Half-Watt SMD 3.5mm (120° Viewing Angle)



## OVS5MxBCR4 Series

### Solder Pad Design

Note: Metal core circuit board (MCPCB) is highly recommended for high density applications. FR-4 board is recommended for other applications

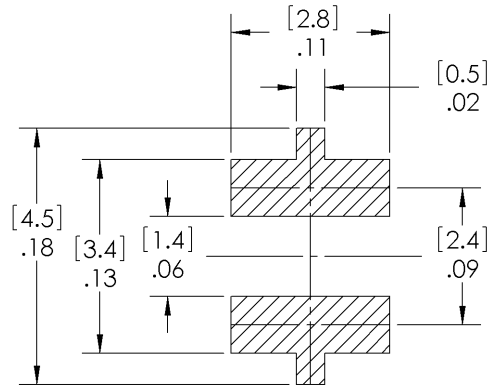

Solder Paste Pattern

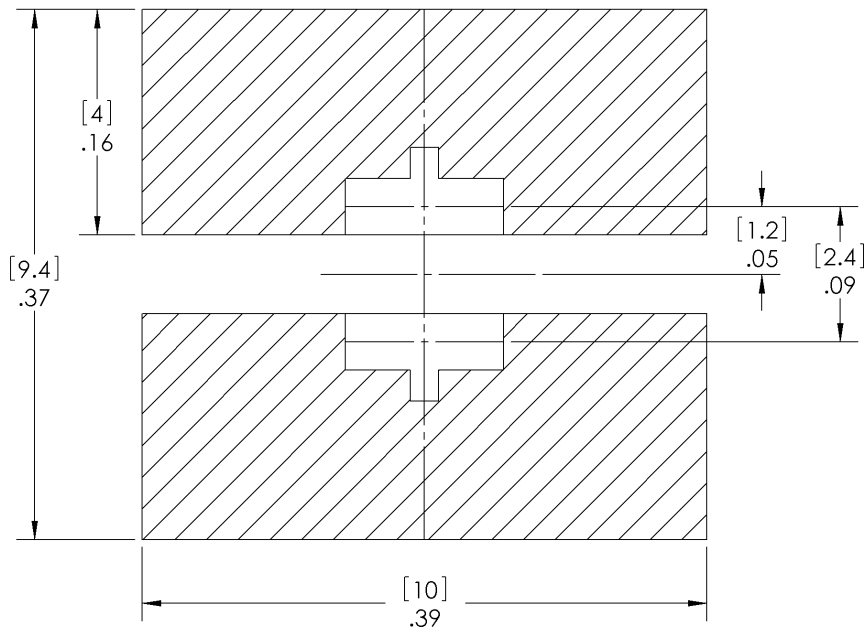

Copper Pattern

#### General Note

TT Electronics reserves the right to make changes in product specification without notice or liability. All information is subject to TT Electronics' own data and is considered accurate at time of going to print.

TT Electronics | OPTEK Technology  
1645 Wallace Drive, Carrollton, TX 75006 | Ph: +1 972 323 2200  
www.ttelectronics.com | www.optekinc.com

# Mini Half-Watt SMD 3.5mm (120° Viewing Angle)



## OVS5MxBCR4 Series

### Recommended Sn-Pb IR-Reflow Soldering Profile.

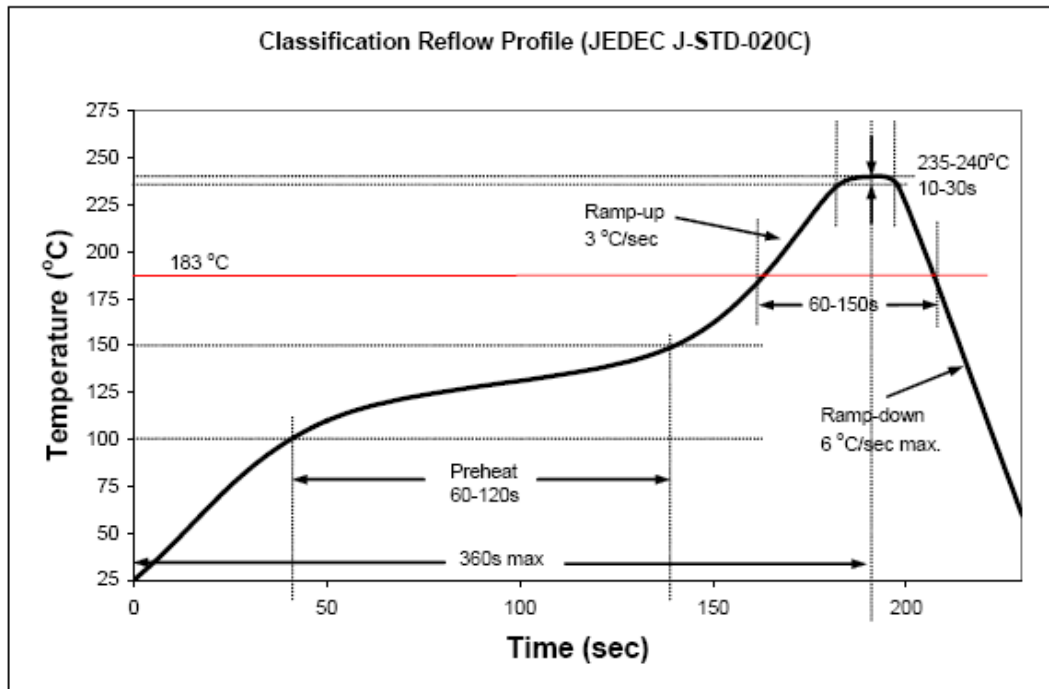

### Recommended Pb Free IR-Reflow Soldering Profile.

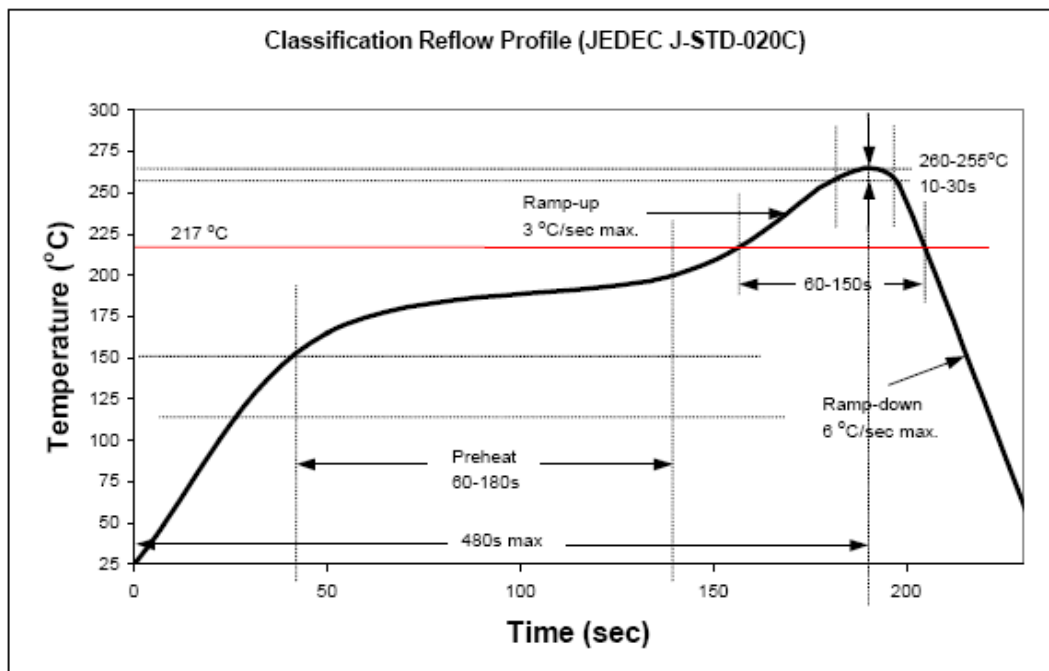

#### General Note

TT Electronics reserves the right to make changes in product specification without notice or liability. All information is subject to TT Electronics' own data and is considered accurate at time of going to print.

TT Electronics | OPTEK Technology  
1645 Wallace Drive, Carrollton, TX 75006 | Ph: +1 972 323 2200  
www.ttelectronics.com | www.optekinc.com

# Mini Half-Watt SMD 3.5mm (120° Viewing Angle)



## OVS5MxBCR4 Series

### Reel Dimensions: 7-inch reel

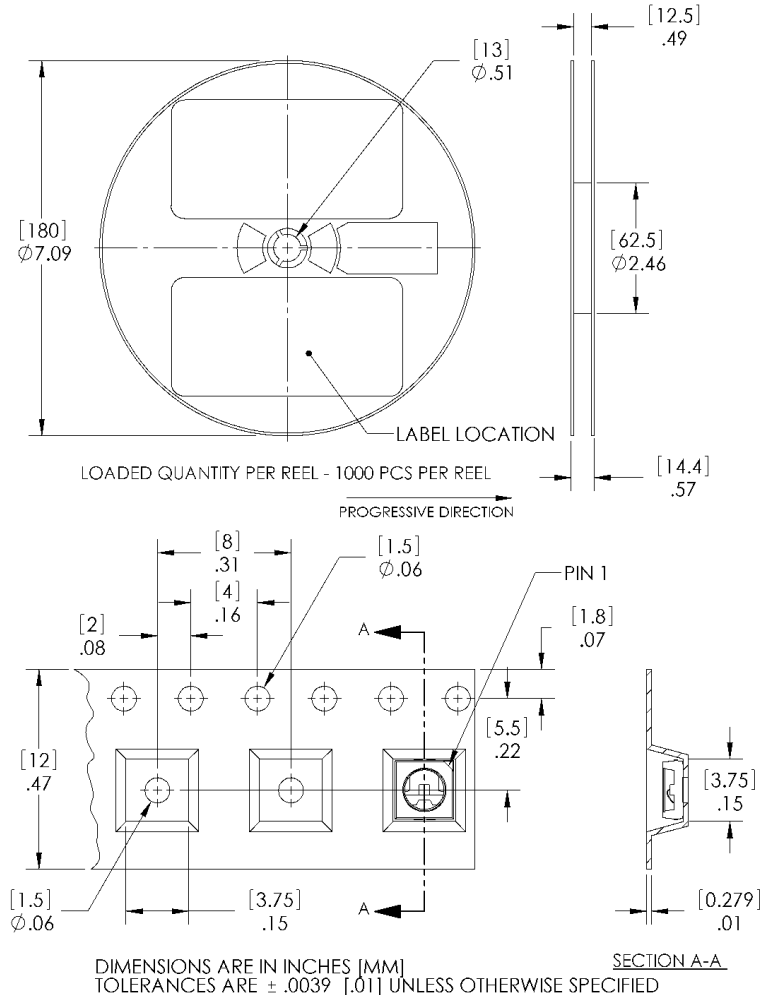

### Carrier Tape Dimensions: Loaded quantity 1000 pieces per reel

### Moisture Resistant Packaging

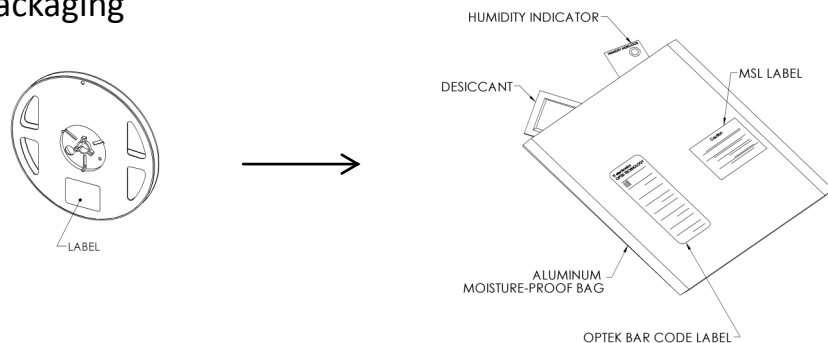

#### General Note

TT Electronics reserves the right to make changes in product specification without notice or liability. All information is subject to TT Electronics' own data and is considered accurate at time of going to print.

TT Electronics | OPTEK Technology  
1645 Wallace Drive, Carrollton, TX 75006 | Ph: +1 972 323 2200  
www.ttelectronics.com | www.optekinc.com