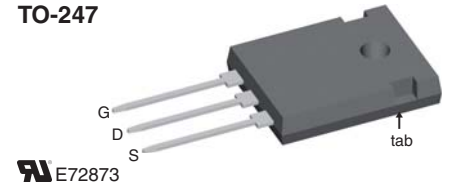

CoolMOS™ 1) Power MOSFET

Low $R_{DS(on)}$, high V_{DSS}
Superjunction MOSFET

$V_{DSS} = 600\text{ V}$
 $I_{D25} = 47\text{ A}$
 $R_{DS(on) \text{ max}} = 70\text{ m}\Omega$

TO-247

MOSFET			
Symbol	Conditions	Maximum Ratings	
V_{DSS}	$T_{VJ} = 25^\circ\text{C}$	600	V
V_{GS}		± 20	V
I_{D25}	$T_C = 25^\circ\text{C}$	47	A
I_{D100}	$T_C = 100^\circ\text{C}$	30	A
E_{AS}	single pulse $I_D = 10\text{ A}; T_C = 25^\circ\text{C}$	1800	mJ
E_{AR}	repetitive $I_D = 20\text{ A}; T_C = 25^\circ\text{C}$	tbd	mJ
dV/dt	MOSFET dV/dt ruggedness $V_{DS} = 0 \dots 480\text{ V}$	tbd	V/ns

Features

- 3rd generation Superjunction power MOSFET
- high blocking capability
- lowest resistance
- avalanche rated for unclamped inductive switching (UIS)
- low thermal resistance due to reduced chip thickness

Applications

- Switched mode power supplies (SMPS)
- Uninterruptible power supplies (UPS)
- Power factor correction (PFC)
- Welding
- Inductive heating

Symbol	Conditions	Characteristic Values			
		$(T_{VJ} = 25^\circ\text{C}, \text{ unless otherwise specified})$			
		min.	typ.	max.	
$R_{DS(on)}$	$V_{GS} = 10\text{ V}; I_D = I_{D100} \text{ }^\ominus$		60	70	m Ω
$V_{GS(th)}$	$V_{DS} = V_{GS}; I_D = 2\text{ mA}$	2		4	V
I_{DSS}	$V_{DS} = V_{DSS}; V_{GS} = 0\text{ V}$			25	μA
				250	μA
I_{GSS}	$V_{GS} = \pm 20\text{ V}; V_{DS} = 0\text{ V}$			± 100	nA
C_{iss}	} $V_{GS} = 0\text{ V}; V_{DS} = 100\text{ V}$ $f = 1\text{ MHz}$		tbd		pF
C_{oss}				tbd	
Q_g	} $V_{GS} = 0\text{ to }10\text{ V}; V_{DS} = 350\text{ V}; I_D = 40\text{ A}$		255	650	nC
Q_{gs}			30		nC
Q_{gd}			110		nC
$t_{d(on)}$	} $V_{GS} = 10\text{ V}; V_{DS} = 380\text{ V}$ $I_D = 47\text{ A}; R_G = 4.7\ \Omega$		20		ns
t_r			27		ns
$t_{d(off)}$			111		ns
t_f			10		ns
R_{thJC}			0.3		K/W

[⊖] Pulse test, $t \leq 300\ \mu\text{s}$, duty cycle $d \leq 2\%$

¹⁾ CoolMOS™ is a trademark of Infineon Technologies AG.

Source-Drain Diode

Symbol	Conditions	Characteristic Values		
		min.	typ.	max.
I_S	$V_{GS} = 0 V$			A
V_{SD}	$I_F = 40 A; V_{GS} = 0 V$			V
t_{rr}	$I_F = 40 A; -di_F/dt = 100 A/\mu s; V_R = 640 V$			ns
Q_{RM}				μC
I_{RM}				A

($T_{VJ} = 25^\circ C$, unless otherwise specified)

Component

Symbol	Conditions	Maximum Ratings	
T_{VJ}	operating	-55...+150	$^\circ C$
T_{stg}		-55...+150	$^\circ C$
M_d	mounting torque	1.13	Nm

Symbol	Conditions	Characteristic Values		
		min.	typ.	max.
R_{thCH}	with heatsink compound		tdb	K/W
Weight			2.7	g

TO-247 Outline

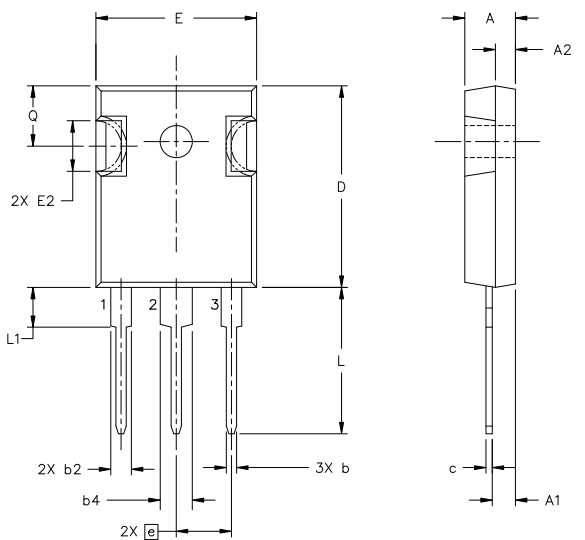

Symbol	Inches		Millimeters	
	min	max	min	max
A	0.185	0.209	4.70	5.30
A1	0.087	0.102	2.21	2.59
A2	0.059	0.098	1.50	2.49
D	0.819	0.845	20.79	21.45
E	0.610	0.640	15.48	16.24
E2	0.170	0.216	4.31	5.48
e	0.215 BSC		5.46 BSC	
L	0.780	0.800	19.80	20.30
L1	-	0.177	-	4.49
$\emptyset P$	0.140	0.144	3.55	3.65
Q	0.212	0.244	5.38	6.19
S	0.242 BSC		6.14 BSC	
b	0.039	0.055	0.99	1.40
b2	0.065	0.094	1.65	2.39
b4	0.102	0.135	2.59	3.43
c	0.015	0.035	0.38	0.89
D1	0.515	-	13.07	-
D2	0.020	0.053	0.51	1.35
E1	0.530	-	13.45	-
$\emptyset P1$	-	0.291	-	7.39

IXYS reserves the right to change limits, test conditions and dimensions.

20080523a

Fig. 1. Output Characteristics @ 25 Deg. C

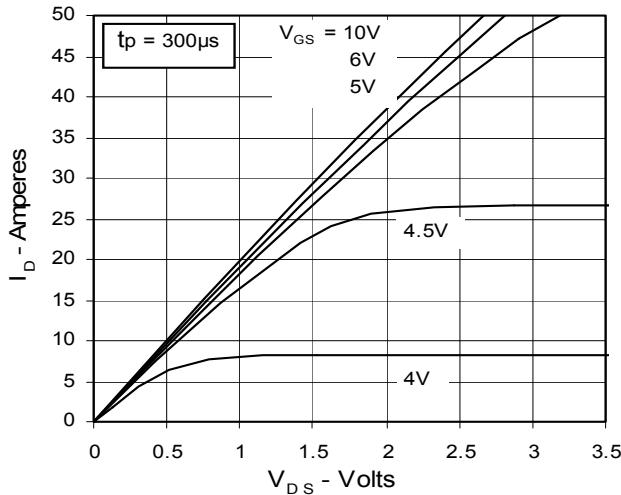

Fig. 2. Extended Output Characteristics @ 25 deg. C

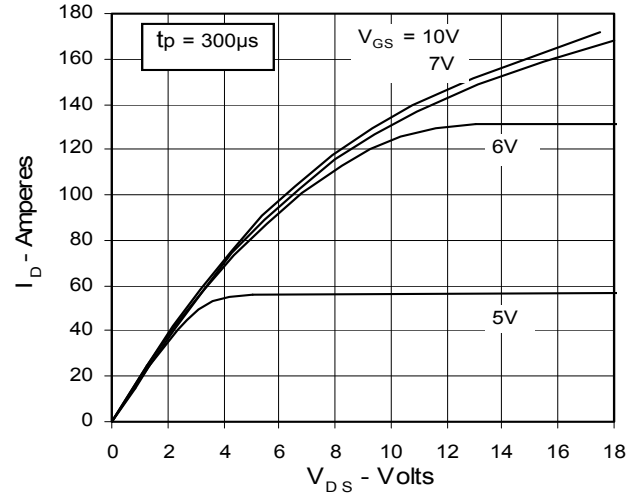

Fig. 3. Output Characteristics @ 125 Deg. C

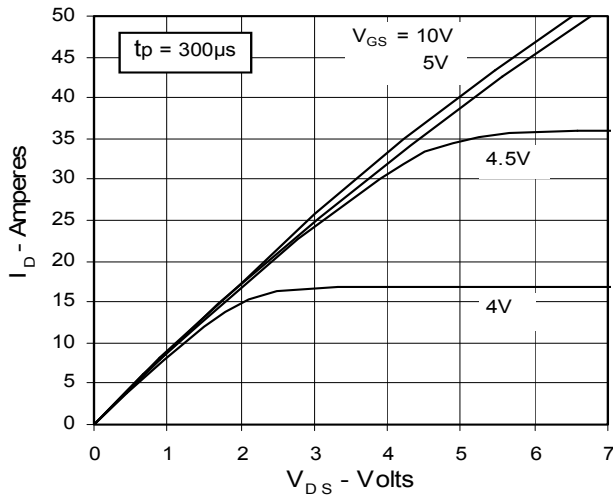

Fig. 4. $R_{DS(on)}$ Normalized to I_{D100} Value vs. Junction Temperature

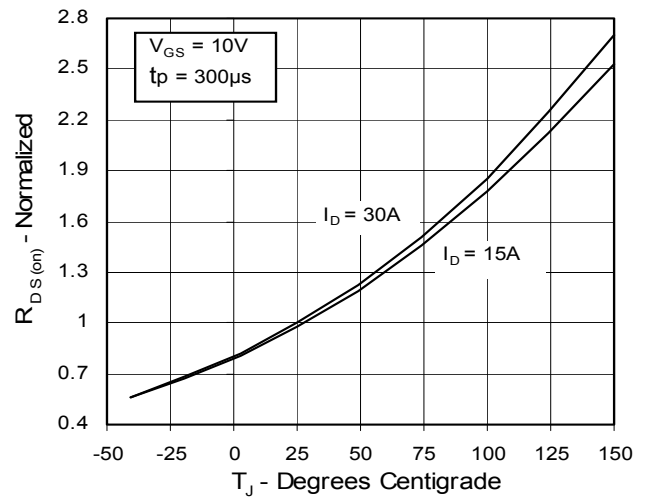

Fig. 5. $R_{DS(on)}$ Normalized to I_{D100} Value vs. I_D

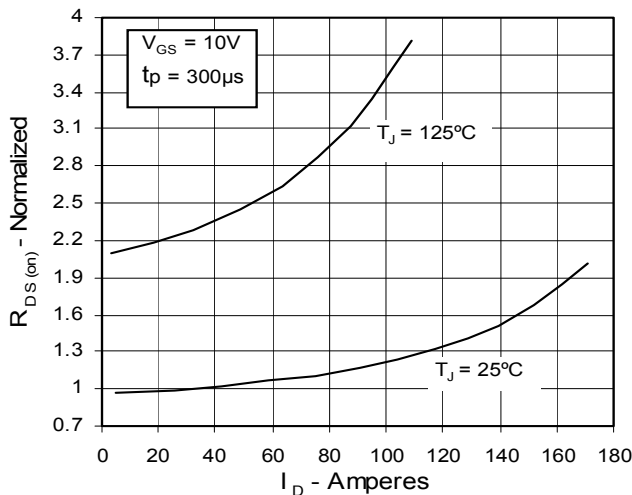

Fig. 6. Drain Current vs. Case Temperature

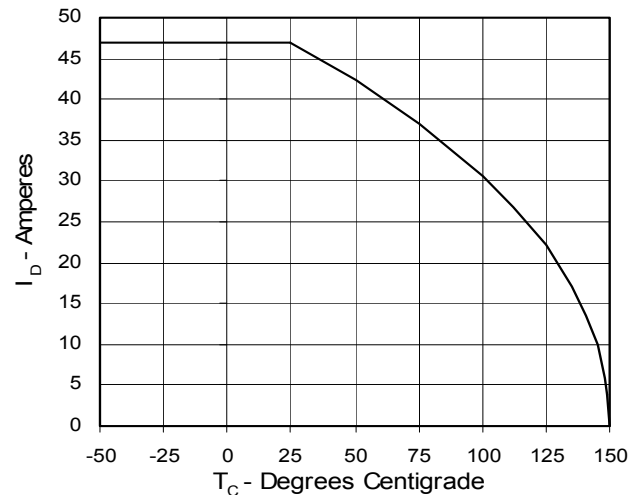

Fig. 7. Input Admittance

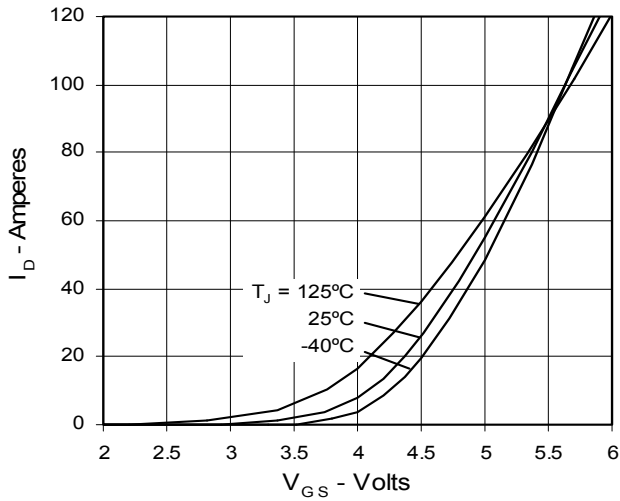

Fig. 8. Transconductance

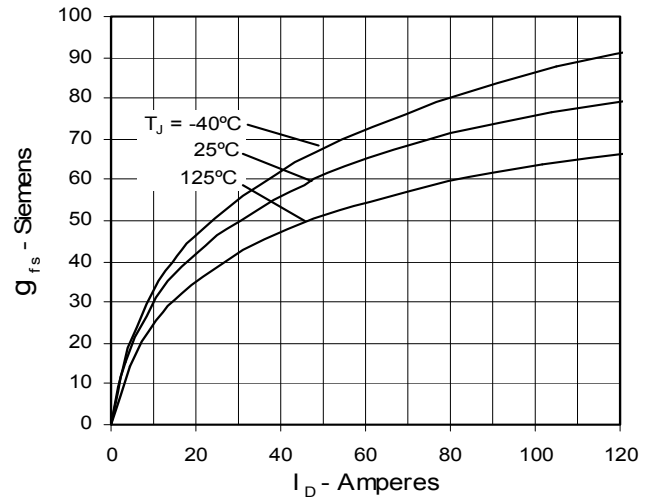

Fig. 9. Source Current vs. Source-To-Drain Voltage

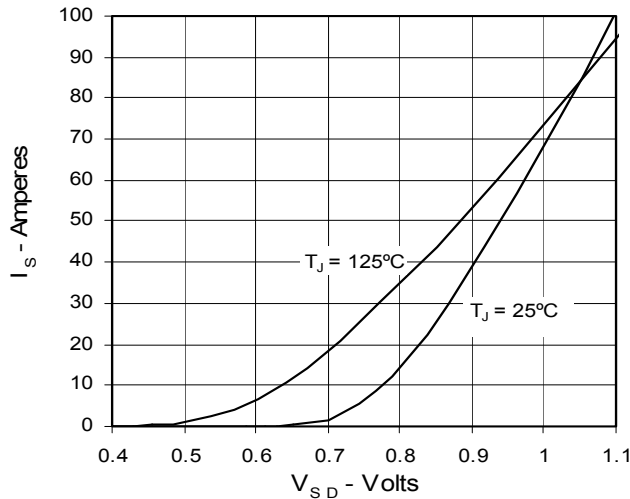

Fig. 10. Gate Charge

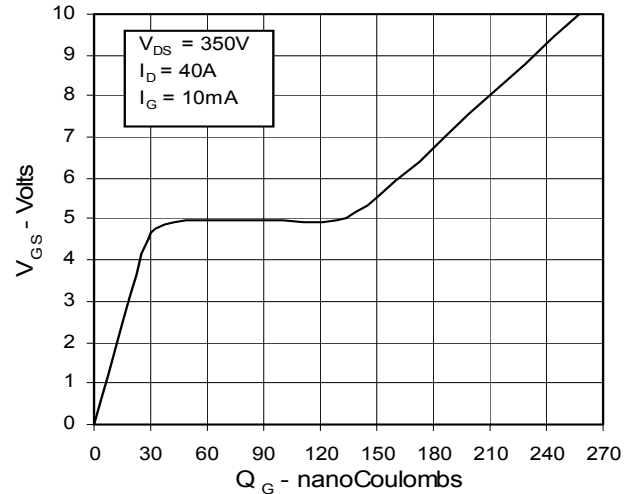

Fig. 11. Capacitance

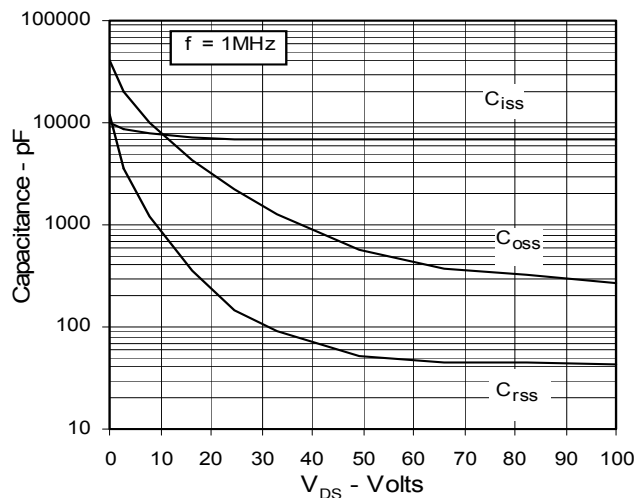
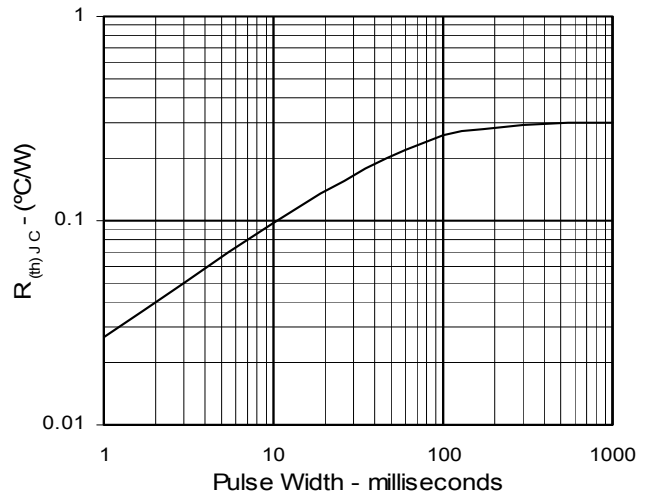

Fig. 12. Maximum Transient Thermal Resistance





Disclaimer Notice - Information furnished is believed to be accurate and reliable. However, users should independently evaluate the suitability of and test each product selected for their own applications. Littelfuse products are not designed for, and may not be used in, all applications. Read complete Disclaimer Notice at www.littelfuse.com/disclaimer-electronics.