

MOSFET - Power, Single N-Channel, PQFN8 5x6 150 V, 11.5 mΩ, 78 A



ON Semiconductor®

www.onsemi.com

NTMFS011N15MC

Features

- Small Footprint (5 x 6 mm) for Compact Design
- Low $R_{DS(on)}$ to Minimize Conduction Losses
- Low Q_G and Capacitance to Minimize Driver Losses
- These Devices are Pb-Free, Halogen Free/BFR Free and are RoHS Compliant

Typical Applications

- Synchronous Rectification
- AC-DC and DC-DC Power Supplies
- AC-DC Adapters (USB PD) SR
- Load Switch

MAXIMUM RATINGS ($T_J = 25^\circ\text{C}$, Unless otherwise specified)

Parameter			Symbol	Value	Unit
Drain-to-Source Breakdown Voltage			$V_{(BR)DSS}$	150	V
Gate-to-Source Voltage			V_{GS}	± 20	V
Continuous Drain Current $R_{\theta JC}$ (Note 2)	Steady State	$T_C = 25^\circ\text{C}$	I_D	78	A
			P_D	147	W
Continuous Drain Current $R_{\theta JA}$ (Note 1, 2)	Steady State	$T_A = 25^\circ\text{C}$	I_D	10.7	A
			P_D	2.7	W
Pulsed Drain Current	$T_A = 25^\circ\text{C}$, $t_p = 250 \mu\text{s}$	I_{DM}	259	A	
Operating Junction and Storage Temperature			T_J, T_{stg}	-55 to +150	$^\circ\text{C}$
Source Current (Body Diode)			I_S	133	A
Single Pulse Drain-to-Source Avalanche Energy ($I_{AV} = 39 \text{ A}$, $L = 0.1 \text{ mH}$)			E_{AS}	76.1	mJ
Lead Temperature Soldering Reflow for Soldering Purposes (1/8" from case for 10 s)			T_L	300	$^\circ\text{C}$

Stresses exceeding those listed in the Maximum Ratings table may damage the device. If any of these limits are exceeded, device functionality should not be assumed, damage may occur and reliability may be affected.

1. Surface-mounted on FR4 board using 1 in² pad size, 1 oz Cu pad.
2. The entire application environment impacts the thermal resistance values shown, they are not constants and are only valid for the particular conditions noted.

$V_{(BR)DSS}$	$R_{DS(on)}$ MAX	I_D MAX
150 V	11.5 mΩ @ 10 V	35 A
	13.2 mΩ @ 8 V	18 A

N-Channel MOSFET

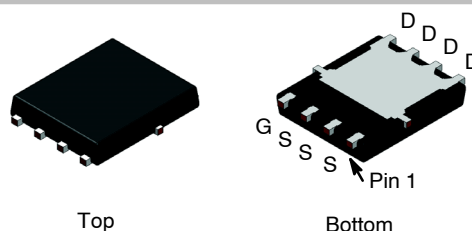
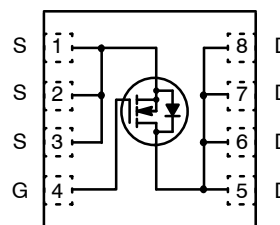

Top

Bottom

PQFN8 5x6
(Power 56)
CASE 483AE

MARKING DIAGRAM

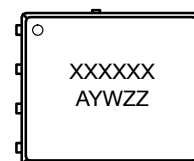

- A = Assembly Location
- Y = Year
- W = Work Week
- ZZ = Lot Traceability

ORDERING INFORMATION

See detailed ordering and shipping information on page 2 of this data sheet.

NTMFS011N15MC

THERMAL CHARACTERISTICS

Symbol	Parameter	Max	Unit
$R_{\theta JC}$	Junction-to-Case – Steady State (Note 5)	0.85	°C/W
$R_{\theta JA}$	Junction-to-Ambient – Steady State (Note 5)	46	

ORDERING INFORMATION

Device	Device Marking	Package	Shipping (Qty / Packing) [†]
NTMFS011N15MC	NTMFS011N15MC	PQFN8 5x6 (Power 56) (Pb-Free/Halogen Free)	3000 / Tape & Reel

[†]For information on tape and reel specifications, including part orientation and tape sizes, please refer to our Tape and Reel Packaging Specifications Brochure, BRD8011/D.

ELECTRICAL CHARACTERISTICS ($T_J = 25^\circ\text{C}$ unless otherwise noted)

Symbol	Parameter	Test Conditions	Min	Typ	Max	Unit
--------	-----------	-----------------	-----	-----	-----	------

OFF CHARACTERISTICS

$V_{(BR)DSS}$	Drain – to – Source Breakdown Voltage	$V_{GS} = 0\text{ V}, I_D = 250\ \mu\text{A}$	150			V
$V_{(BR)DSS} / T_J$	Drain – to – Source Breakdown Voltage Temperature Coefficient	$I_D = 250\ \mu\text{A}, \text{ref to } 25^\circ\text{C}$		85		mV/°C
I_{DSS}	Zero Gate Voltage Drain Current	$V_{GS} = 0\text{ V}, V_{DS} = 120\text{ V}$	$T_J = 25^\circ\text{C}$		1	μA
			$T_J = 125^\circ\text{C}$		100	
I_{GSS}	Gate – to – Source Leakage Current	$V_{DS} = 0\text{ V}, V_{GS} = \pm 20\text{ V}$			± 100	nA

ON CHARACTERISTICS (Note 3)

$V_{GS(TH)}$	Gate Threshold Voltage	$V_{GS} = V_{DS}, I_D = 194\ \mu\text{A}$	2.5	3.35	4.5	V
$V_{GS(TH)} / I_J$	Negative Threshold Temperature Coefficient	$I_D = 250\ \mu\text{A}, \text{ref to } 25^\circ\text{C}$		-7.2		mV/°C
$R_{DS(on)}$	Drain – to – Source On Resistance	$V_{GS} = 10\text{ V}, I_D = 35\text{ A}$		9.0	11.5	m Ω
		$V_{GS} = 8\text{ V}, I_D = 18\text{ A}$		9.7	13.2	
g_{FS}	Forward Transconductance	$V_{DS} = 10\text{ V}, I_D = 18\text{ A}$		96	116	S
R_G	Gate-Resistance	$T_A = 25^\circ\text{C}$		0.9	1.1	Ω

CHARGES & CAPACITANCES

C_{ISS}	Input Capacitance	$V_{GS} = 0\text{ V}, f = 1\text{ MHz}, V_{DS} = 75\text{ V}$		2478	3592	pF
C_{OSS}	Output Capacitance			728	1092	
C_{RSS}	Reverse Transfer Capacitance			7.9	15	
$Q_{G(TOT)}$	Total Gate Charge	$V_{GS} = 8\text{ V}, V_{DS} = 75\text{ V}, I_D = 35\text{ A}$		30.6	46	nC
$Q_{G(TOT)}$	Total Gate Charge	$V_{GS} = 10\text{ V}, V_{DS} = 75\text{ V}, I_D = 35\text{ A}$		30.7	46	
Q_{GS}	Gate-to-Source Charge			12.8		
Q_{SW}	Switching Charge			9.4		
Q_{GD}	Gate-to-Drain Charge			4.5		
Q_{OSS}	Output Charge	$V_{GS} = 0\text{ V}, V_{DD} = 75\text{ V}$		95		
V_{GP}	Plateau Voltage	$V_{GS} = 10\text{ V}, V_{DS} = 75\text{ V}, I_D = 35\text{ A}$		5.1		

SWITCHING CHARACTERISTICS (Note 3)

$t_{d(ON)}$	Turn – On Delay Time	$V_{GS} = 10\text{ V}, V_{DS} = 75\text{ V}, I_D = 35\text{ A}, R_G = 6\ \Omega$		19.8		ns
t_r	Rise Time			4.7		
$t_{d(OFF)}$	Turn – Off Delay Time			25.5		
t_f	Fall Time			4.0		

NTMFS011N15MC

ELECTRICAL CHARACTERISTICS ($T_J = 25^\circ\text{C}$ unless otherwise noted) (continued)

Symbol	Parameter	Test Conditions	Min	Typ	Max	Unit
--------	-----------	-----------------	-----	-----	-----	------

DRAIN-SOURCE DIODE CHARACTERISTICS

V_{SD}	Forward Diode Voltage	$V_{GS} = 0\text{ V}, I_S = 35\text{ A}$	$T_J = 25^\circ\text{C}$	0.869		V
			$T_J = 125^\circ\text{C}$	0.725		
t_{RR}	Reverse Recovery Time	$V_{GS} = 0\text{ V}, dI_S/dt = 300\text{ A}/\mu\text{s}, I_S = 35\text{ A}$		48.8		ns
Q_{RR}	Reverse Recovery Charge			227		nC
t_{RR}	Reverse Recovery Time	$V_{GS} = 0\text{ V}, dI_S/dt = 1000\text{ A}/\mu\text{s}, I_S = 35\text{ A}$		36.4		ns
Q_{RR}	Reverse Recovery Charge			407		nC

Product parametric performance is indicated in the Electrical Characteristics for the listed test conditions, unless otherwise noted. Product performance may not be indicated by the Electrical Characteristics if operated under different conditions.

3. Switching characteristics are independent of operating junction temperatures.

NOTES:

4. $R_{\theta JA}$ is determined with the device mounted on a 1 in² pad 2 oz copper pad on a 1.5 x 1.5 in. board of FR-4 material. $R_{\theta CA}$ is determined by the user's board design.

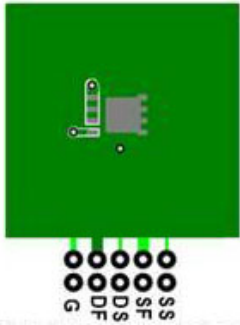

a) 46°C/W when mounted on a 1 in² pad of 2 oz copper.

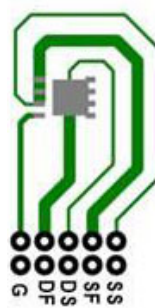

b) 116°C/W when mounted on a minimum pad of 2 oz copper.

5. Pulse Test: Pulse Width < 300 μs , Duty cycle < 2.0%.

6. E_{AS} of 196 mJ is based on starting $T_J = 25^\circ\text{C}$; $L = 3\text{ mH}$, $I_{AS} = 12.7\text{ A}$, $V_{DD} = 100\text{ V}$, $V_{GS} = 15\text{ V}$. 100% tested at $L = 0.1\text{ mH}$, $I_{AS} = 41\text{ A}$.

7. Pulsed I_D please refer to Fig 11 SOA graph for more details.

8. Computed continuous current limited to Max Junction Temperature only, actual continuous current will be limited by thermal & electro-mechanical application board design.

NTMFS011N15MC

TYPICAL CHARACTERISTICS ($T_J = 25^\circ\text{C}$ unless otherwise noted.)

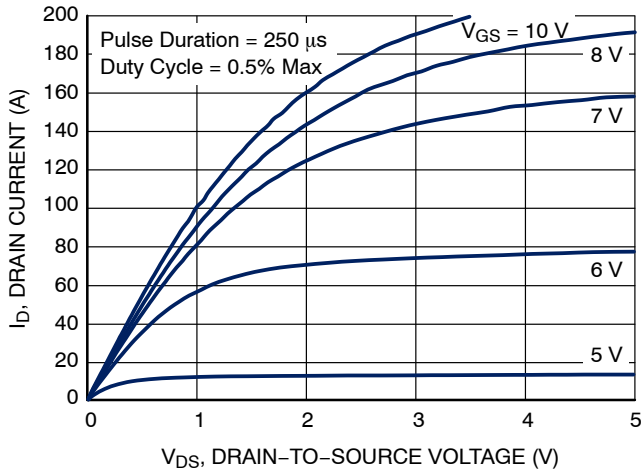

Figure 1. On-Region Characteristics

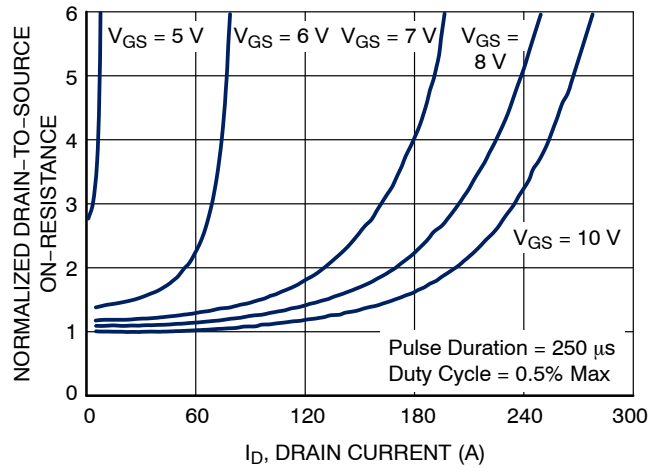

Figure 2. Normalized On-Resistance vs. Drain Current and Gate Voltage

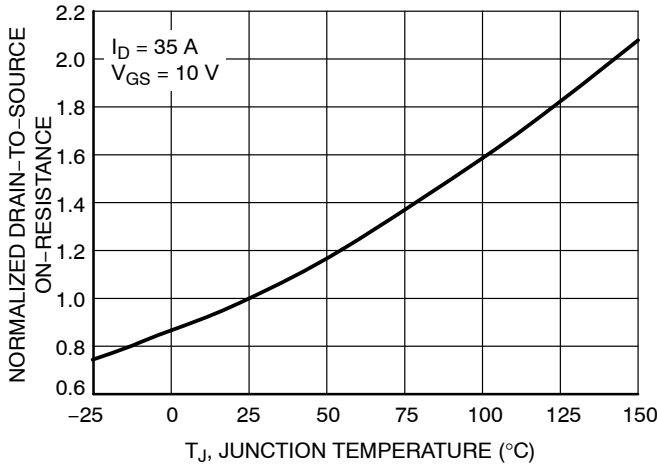

Figure 3. Normalized On-Resistance vs. Junction Temperature

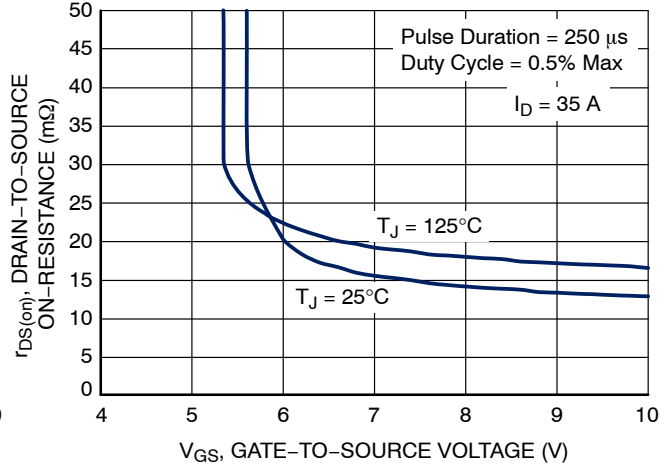

Figure 4. On-Resistance vs. Gate-to-Source Voltage

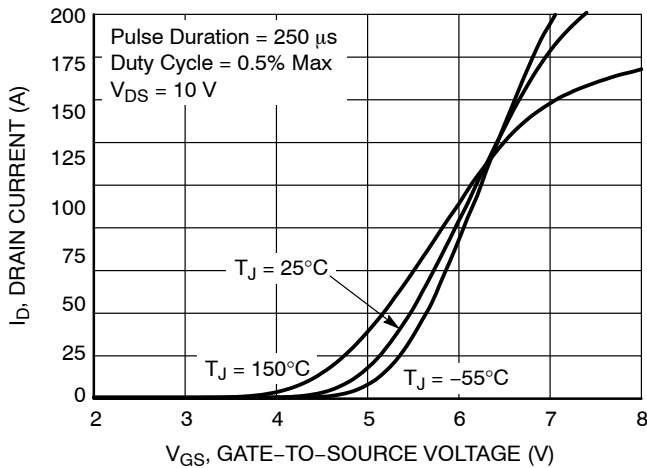

Figure 5. Transfer Characteristics

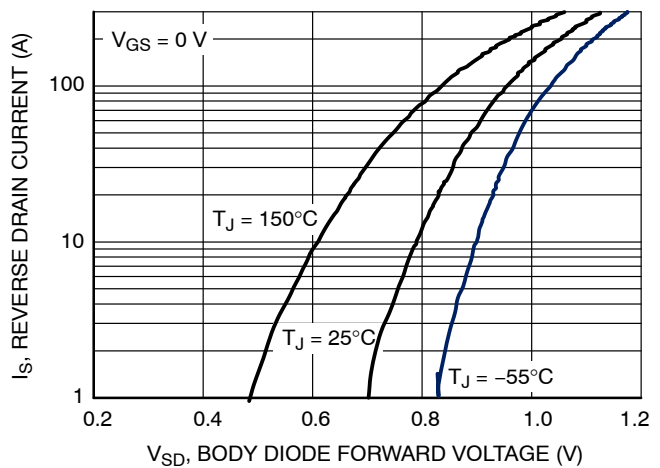

Figure 6. Source-to-Drain Diode Forward Voltage vs. Source Current

NTMFS011N15MC

TYPICAL CHARACTERISTICS ($T_J = 25^\circ\text{C}$ unless otherwise noted.)

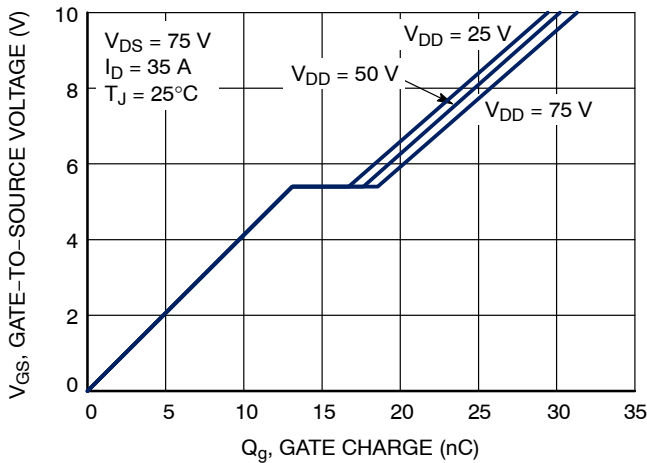

Figure 7. Gate Charge Characteristics

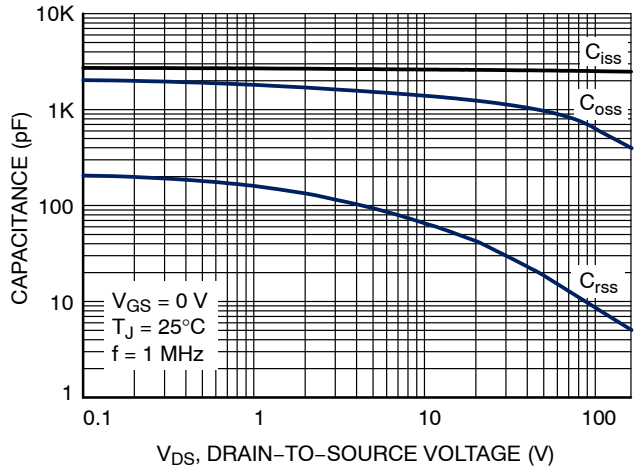

Figure 8. Capacitance vs. Drain-to-Source Voltage

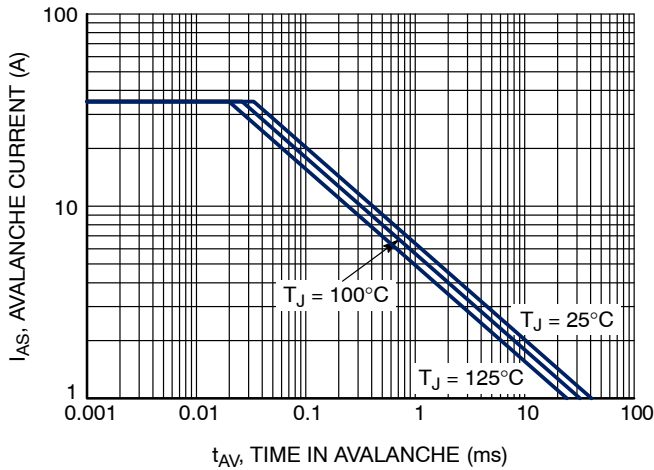

Figure 9. Unclamped Inductive Switching Capability

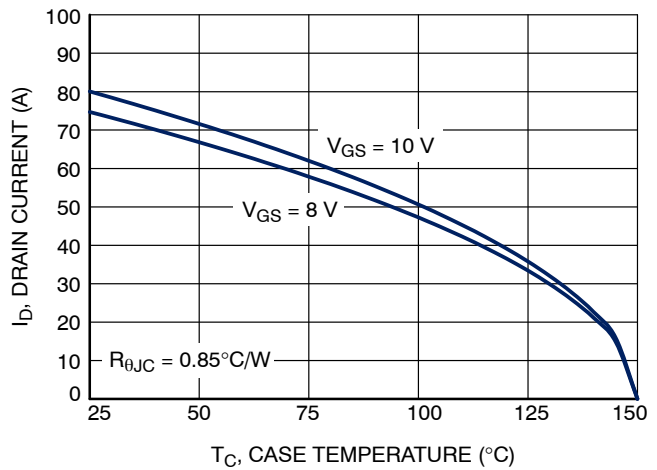

Figure 10. Maximum Continuous Drain Current vs. Case Temperature

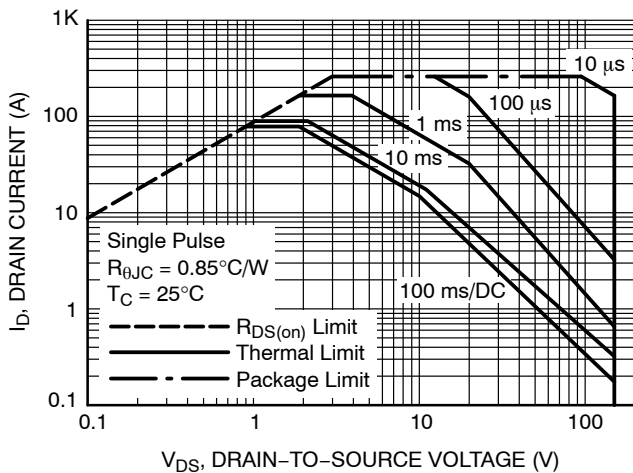

Figure 11. Forward Bias Safe Operating Area

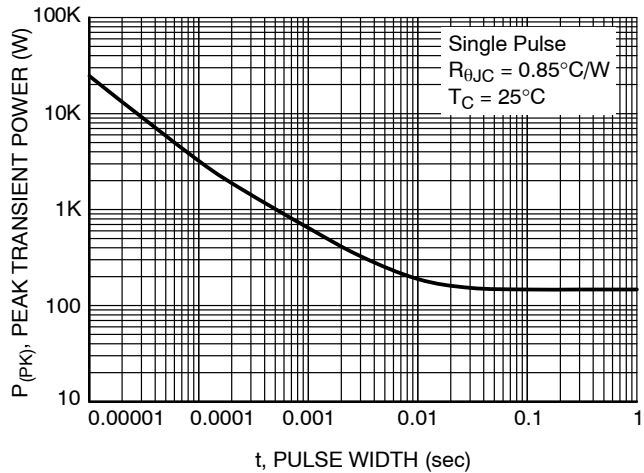

Figure 12. Single Pulse Maximum Power Dissipation

NTMFS011N15MC

TYPICAL CHARACTERISTICS ($T_J = 25^\circ\text{C}$ unless otherwise noted.)

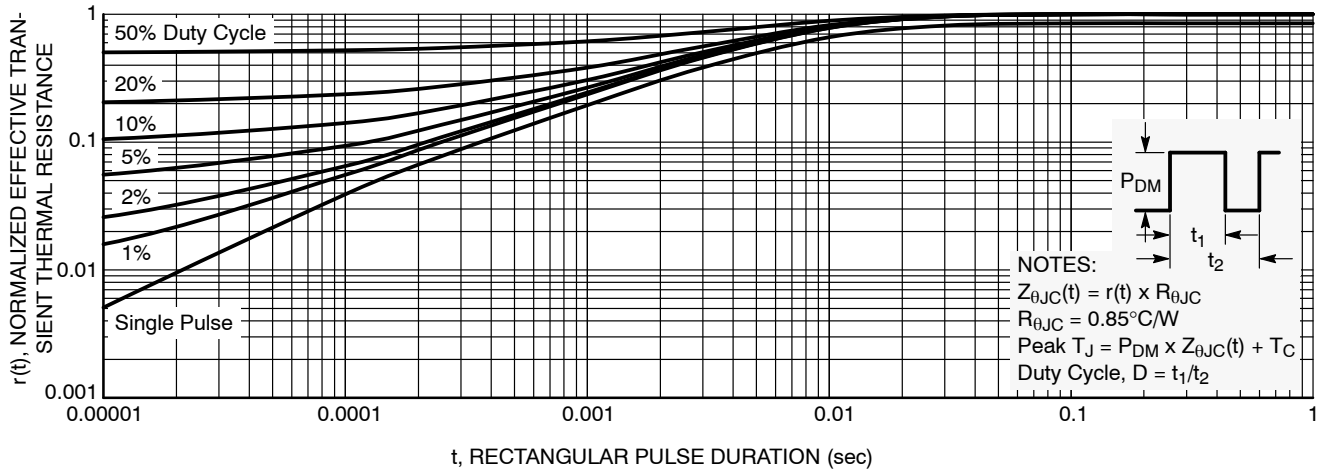

Figure 13. Junction-to-Case Transient Thermal Response Curve

MECHANICAL CASE OUTLINE PACKAGE DIMENSIONS



PQFN8 5X6, 1.27P
CASE 483AE
ISSUE C

DATE 21 JAN 2022

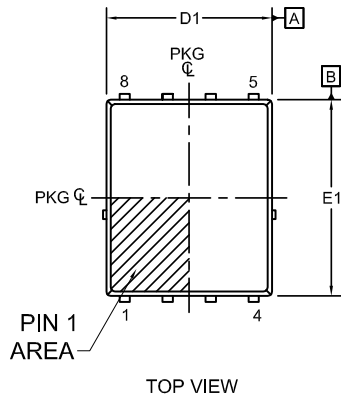

NOTES:

1. DIMENSIONING AND TOLERANCING PER ASME Y14.5M, 2009.
2. CONTROLLING DIMENSION: MILLIMETERS
3. COPLANARITY APPLIES TO THE EXPOSED PADS AS WELL AS THE TERMINALS.
4. DIMENSIONS D1 AND E1 DO NOT INCLUDE MOLD FLASH, PROTRUSIONS, OR GATE BURRS.
5. SEATING PLANE IS DEFINED BY THE TERMINALS. "A1" IS DEFINED AS THE DISTANCE FROM THE SEATING PLANE TO THE LOWEST POINT ON THE PACKAGE BODY.
6. IT IS RECOMMENDED TO HAVE NO TRACES OR VIAS WITHIN THE KEEP OUT AREA.

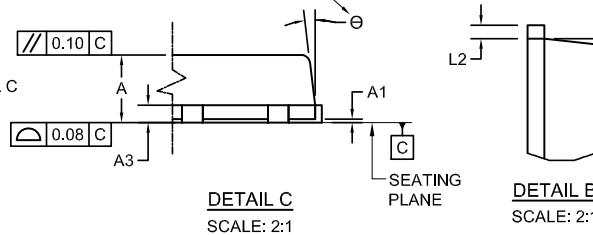

DIM	MILLIMETERS		
	MIN.	NOM.	MAX.
A	0.90	1.00	1.10
A1	0.00	-	0.05
b	0.21	0.31	0.41
b1	0.31	0.41	0.51
A3	0.15	0.25	0.35
D	4.90	5.00	5.20
D1	4.80	4.90	5.00
D2	3.61	3.82	3.96
E	5.90	6.15	6.25
E1	5.70	5.80	5.90
E2	3.38	3.48	3.78
E3	0.30 REF		
E4	0.52 REF		
e	1.27 BSC		
e/2	0.635 BSC		
e1	3.81 BSC		
e2	0.50 REF		
L	0.51	0.66	0.76
L2	0.05	0.18	0.30
L4	0.34	0.44	0.54
z	0.34 REF		
θ	0°	-	12°

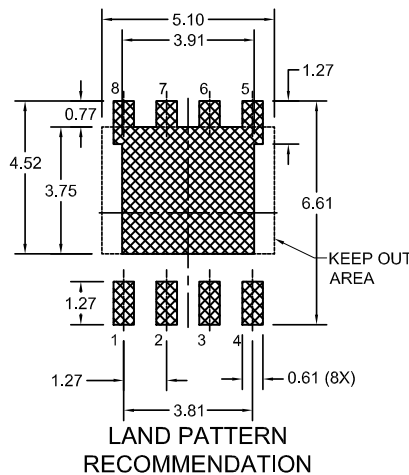
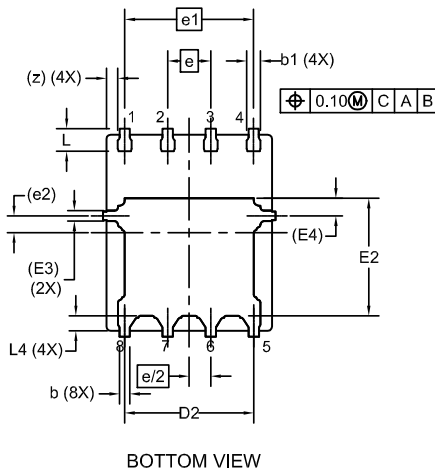

*FOR ADDITIONAL INFORMATION ON OUR PB-FREE STRATEGY AND SOLDERING DETAILS, PLEASE DOWNLOAD THE ON SEMICONDUCTOR SOLDERING AND MOUNTING TECHNIQUES REFERENCE MANUAL, SOLDERRM/D.

DOCUMENT NUMBER:	98AON13655G	Electronic versions are uncontrolled except when accessed directly from the Document Repository. Printed versions are uncontrolled except when stamped "CONTROLLED COPY" in red.
DESCRIPTION:	PQFN8 5X6, 1.27P	PAGE 1 OF 1

onsemi and ONSEMI are trademarks of Semiconductor Components Industries, LLC dba onsemi or its subsidiaries in the United States and/or other countries. onsemi reserves the right to make changes without further notice to any products herein. onsemi makes no warranty, representation or guarantee regarding the suitability of its products for any particular purpose, nor does onsemi assume any liability arising out of the application or use of any product or circuit, and specifically disclaims any and all liability, including without limitation special, consequential or incidental damages. onsemi does not convey any license under its patent rights nor the rights of others.

onsemi, **Onsemi**, and other names, marks, and brands are registered and/or common law trademarks of Semiconductor Components Industries, LLC dba "**onsemi**" or its affiliates and/or subsidiaries in the United States and/or other countries. **onsemi** owns the rights to a number of patents, trademarks, copyrights, trade secrets, and other intellectual property. A listing of **onsemi**'s product/patent coverage may be accessed at www.onsemi.com/site/pdf/Patent-Marking.pdf. **onsemi** reserves the right to make changes at any time to any products or information herein, without notice. The information herein is provided "as-is" and **onsemi** makes no warranty, representation or guarantee regarding the accuracy of the information, product features, availability, functionality, or suitability of its products for any particular purpose, nor does **onsemi** assume any liability arising out of the application or use of any product or circuit, and specifically disclaims any and all liability, including without limitation special, consequential or incidental damages. Buyer is responsible for its products and applications using **onsemi** products, including compliance with all laws, regulations and safety requirements or standards, regardless of any support or applications information provided by **onsemi**. "Typical" parameters which may be provided in **onsemi** data sheets and/or specifications can and do vary in different applications and actual performance may vary over time. All operating parameters, including "Typicals" must be validated for each customer application by customer's technical experts. **onsemi** does not convey any license under any of its intellectual property rights nor the rights of others. **onsemi** products are not designed, intended, or authorized for use as a critical component in life support systems or any FDA Class 3 medical devices or medical devices with a same or similar classification in a foreign jurisdiction or any devices intended for implantation in the human body. Should Buyer purchase or use **onsemi** products for any such unintended or unauthorized application, Buyer shall indemnify and hold **onsemi** and its officers, employees, subsidiaries, affiliates, and distributors harmless against all claims, costs, damages, and expenses, and reasonable attorney fees arising out of, directly or indirectly, any claim of personal injury or death associated with such unintended or unauthorized use, even if such claim alleges that **onsemi** was negligent regarding the design or manufacture of the part. **onsemi** is an Equal Opportunity/Affirmative Action Employer. This literature is subject to all applicable copyright laws and is not for resale in any manner.

ADDITIONAL INFORMATION

TECHNICAL PUBLICATIONS:

Technical Library: www.onsemi.com/design/resources/technical-documentation
onsemi Website: www.onsemi.com

ONLINE SUPPORT: www.onsemi.com/support

For additional information, please contact your local Sales Representative at www.onsemi.com/support/sales