

FEATURES

- Flat Gain
- Very Low Distortion
- Excellent Input/Output Match
- Low DC Power Consumption
- Good RF Stability with High VSWR Load Conditions
- Surface Mount Package Compatible with Automatic Assembly
- Low Cost
- Repeatability of Monolithic Fabrication
- Meets Cenelec Standard
- RoHS-Compliant Package Options

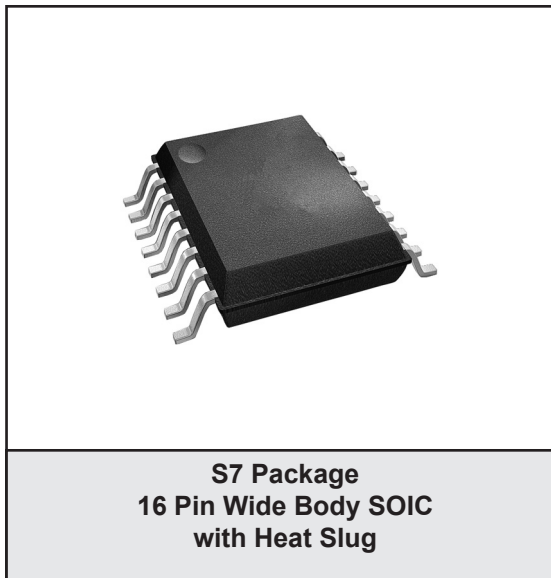

PRODUCT DESCRIPTION

The ACA0861 family of surface mount monolithic GaAs RF Linear Amplifiers has been developed to replace, in new designs, the standard CATV Hybrid amplifiers currently in use. The MMICs consist of two parallel amplifiers, each with 12 dB gain. The Amplifiers are optimized for exceptionally low distortion and noise figure while providing flat gain and excellent input and output return loss. There are four differently specified amplifiers available: two input stages and two output stages. The ACA0861A and the ACA0861C are input stages and are specified at +34 dBmV flat output. The ACA0861B

and ACA0861D are output stages and are specified at +44 dBmV flat output. A Hybrid equivalent is formed when one input stage ACA0861 is cascaded with an ACA0861 output stage between two transmission line baluns. For low gain applications a single ACA0861 can be used between baluns, for higher gain applications more than two ACA0861 can be cascaded between baluns. See ACA0861 application note for more information.

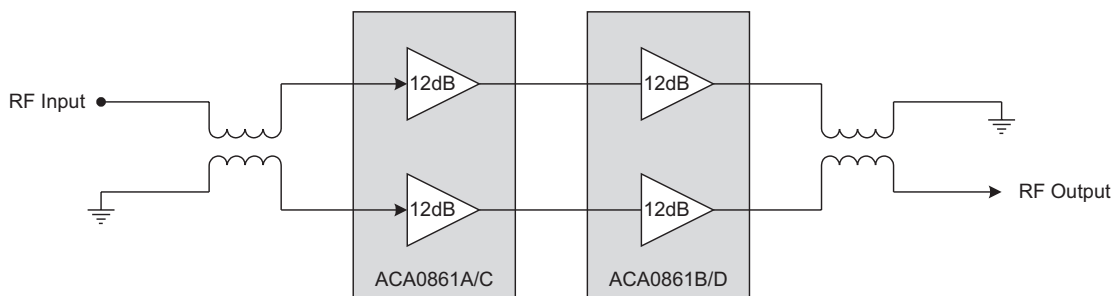

Figure 1: Hybrid Application Diagram

Input Stages

The ACA0861A and the ACA0861C are designed as input stages and are specified at +34 dBmV flat output. These parts can be used alone for low gain, low output level applications or can be cascaded with one of the ACA0861 output stages for higher gain and output signal drive level. The ACA0861A is a low power dissipation part designed to drive the ACA0861B output stage. The ACA0861C is a slightly higher power dissipation part and provides the needed distortion parameters to drive the ACA0861D output stage.

Output Stages

The ACA0861B and ACA0861D are designed as output stages and are specified at +44 dBmV flat output. These parts can be used alone for low gain, high output level applications or can be cascaded with one of the ACA0861 input stages for higher gain. The ACA0861B is a low power dissipation part designed as the output stage with an ACA0861A input stage. The ACA0861D is a higher power dissipation part designed as the output stage with an ACA0861C input stage. Cascaded, an ACA0861A and ACA0861B provide exceptional push-pull hybrid equivalent performance; an ACA0861C and an ACA0861D cascaded provide exceptional power doubling hybrid equivalent performance.

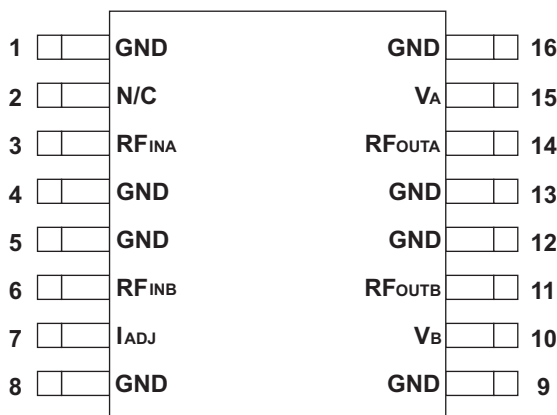

Figure 2: Pin Out

Table 1: Pin Description

PIN	NAME	DESCRIPTION	PIN	NAME	DESCRIPTION
1	GND	Ground	9	GND	Ground
2	N/C	No Connection	10	V _B	Supply for Amplifier B
3	RF _{INA}	Input to Amplifier A	11	RF _{OUTB}	Output from Amplifier B
4	GND	Ground	12	GND	Ground
5	GND	Ground	13	GND	Ground
6	RF _{INB}	Input to Amplifier B	14	RF _{OUTA}	Output from Amplifier A
7	I _{ADJ}	Current Adjust	15	V _A	Supply for Amplifier A
8	GND	Ground	16	GND	Ground

ELECTRICAL CHARACTERISTICS

Table 2: Absolute Minimum and Maximum Ratings

PARAMETER	MIN	MAX	UNIT
Amplifier Supplies (pins 10, 11, 14, 15)	0	+15	VDC
RF Input Power (pins 3, 6)	-	+70	dBmV
Storage Temperature	-65	+150	°C
Soldering Temperature	-	+260	°C
Soldering Time	-	5.0	sec

Stresses in excess of the absolute ratings may cause permanent damage. Functional operation is not implied under these conditions. Exposure to absolute ratings for extended periods of time may adversely affect reliability.

Notes:

1. Pins 3 and 6 should be AC-coupled. No external DC bias should be applied.
2. Pin 7 should be pulled to ground through a resistor or left open-circuited. No external DC bias should be applied.

Table 3: Operating Ranges

PARAMETER	MIN	TYP	MAX	UNIT
RF Frequency	40	-	860	MHz
Supply: V _D (pins 10, 11, 14, 15)	-	+12	-	VDC
Operating Temperature: T _A	-40	-	+110	°C

The device may be operated safely over these conditions; however, parametric performance is guaranteed only over the conditions defined in the electrical specifications.

Table 4: Electrical Specifications
(T_A = +25 °C, V_D = +12 VDC)

PARAMETER	ACA0861A			ACA0861B			ACA0861C			ACA0861D			UNIT
	MIN	TYP	MAX	MIN	TYP	MAX	MIN	TYP	MAX	MIN	TYP	MAX	
Gain ⁽¹⁾	11.4	11.9	12.4	11.5	12	12.5	11.5	12	12.5	11.6	12.1	12.6	dB
Gain Flatness ⁽¹⁾	-	-	±0.3	-	-	±0.3	-	-	±0.3	-	-	±0.3	dB
Noise Figure ⁽²⁾	-	3	5	-	3	5	-	3	5	-	3	6	dB
CTB ^{(2),(3)}													
77 Channels	-	-70	-	-	-62	-	-	-77	-	-	-70	-	dBc
110 Channels	-	-68	-64	-	-60	-57	-	-75	-68	-	-68	-66	
128 Channels	-	-65	-	-	-58	-	-	-71	-	-	-67	-	
CSO ^{(2),(3)}													
77 Channels	-	-71	-	-	-66	-	-	-75	-	-	-72	-	dBc
110 Channels	-	-71	-66	-	-66	-60	-	-75	-68	-	-72	-68	
128 Channels	-	-70	-	-	-64	-	-	-73	-	-	-70	-	
XMOD ^{(2),(3)}													
77 Channels	-	-67	-	-	-62	-	-	-74	-	-	-71	-	dBc
110 Channels	-	-63	-56	-	-56	-50	-	-71	-62	-	-68	-61	
128 Channels	-	-59	-	-	-55	-	-	-67	-	-	-66	-	
Supply Current ⁽⁴⁾	-	180	200	-	310	330	-	260	275	-	450	490	mA
Cable Equivalent Slope ⁽¹⁾	-0.5	-	1.0	-0.5	-	1.0	-0.5	-	1.0	-0.5	-	1.0	dB
Return Loss (Input/Output) ⁽¹⁾	18	22	-	18	22	-	18	22	-	18	22	-	dB
Thermal Resistance (R _{jc})	-	-	6.0	-	-	6.0	-	-	6.0	-	-	6.0	□/W

Notes:

- (1) Measured performance of MMIC alone. Balun effects de-embedded from measurement.
(2) Measured with a balun on input and output of the device. See Figure 3 for test setup.
(3) All parts measured with 110 channel flat input. Parts A and C measured at +34 dBmV output (per channel). Parts B and D measured at +44 dBmV output (per channel).
(4) A fixed resistor is needed for parts A through C; part D does not need an external resistor (see Table 6.) These resistors set the devices' current draw. Bias voltage is +12 VDC.

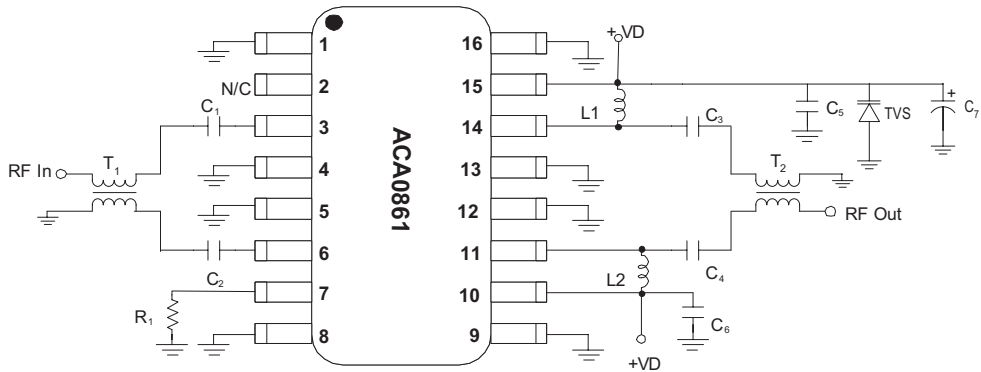

Note: Apply voltage to both V_D lines simultaneously.

Figure 3: Test Circuit

Table 5: Parts List for Test Circuit

REF	DESCRIPTION	QTY	VENDOR	VENDOR PART NO.
C1, C2, C5, C6	0.01uF chip capacitor	4	Murata	GRM39X7R1103K25V
C3, C4	300pF chip capacitor	2	Murata	GRM39X7R301K25V
C7	47uF Electrolytic CAP	1	Digi-Key Corp.	P5275-ND
L1, L2	390nH air-wound chip inductor	2	Coilcraft	1008CS-391
R1	(see Table 6)	1		
T1, T2 ⁽¹⁾	ferrite core	2	Philips	TC3.4/1.8/1.3-3D3
	wire		MWS Wire industries	B238611
TVS	TVS, 12 Volt, 600 Watt	1	Digi-Key Corp.	SMBJ12ACCCT-ND

Notes:

(1) T1, T2 (balun) wind 4 turns thru core, as shown in Figure 4.

DO NOT SEPARATE BIFILAR WIRES.

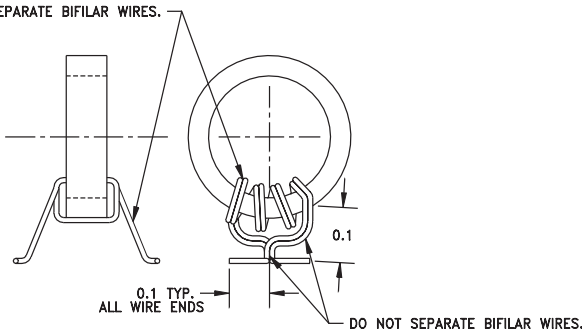

Table 6: R1 Resistor Value

PART NUMBER	R1 VALUE
ACA0861A	21.5 Ohms
ACA0861B	274 Ohms
ACA0861C	121 Ohms
ACA0861D	(open)

NOTES: 1. MATERIAL:

CORE: PHILLIPS (135 CT 050-3D3)
 WIRE: MWS WIRE IND.
 B2383611(66256-01)
 4 TIMES THRU CENTER
 AS SHOWN IN FIGURE.

Figure 4: Balun Drawing (4 Turns)

PERFORMANCE DATA

ACA0861A and ACA0861B Cascade Typical Data (see Figure 42)

Figure 5: Gain / S21

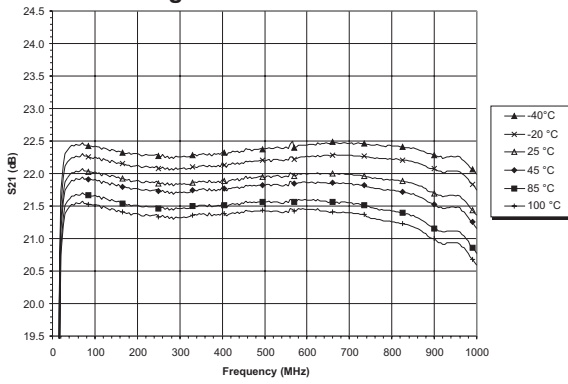

Figure 6: Reverse Isolation / S12

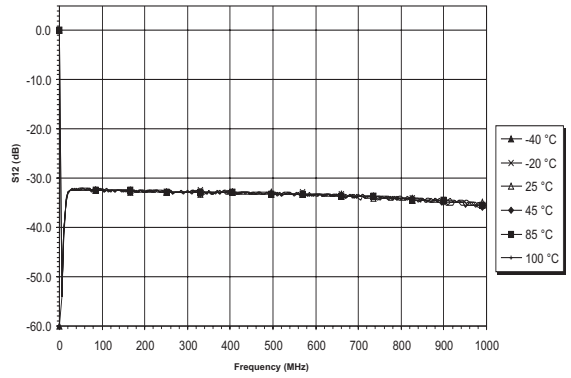

Figure 7: Input Return Loss / S11

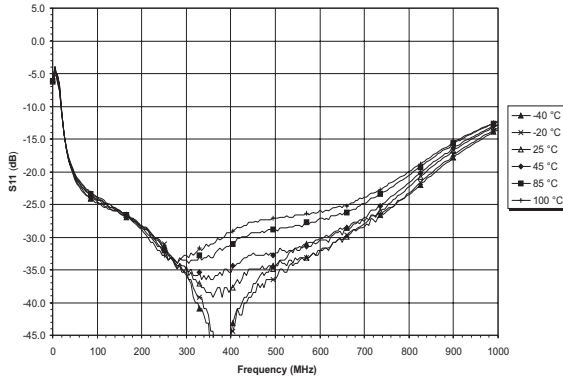

Figure 8: Noise Figure vs. Frequency

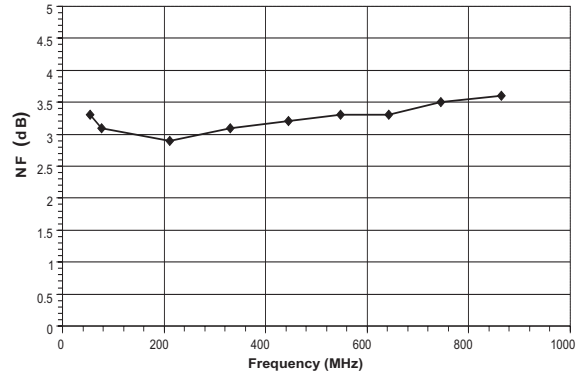
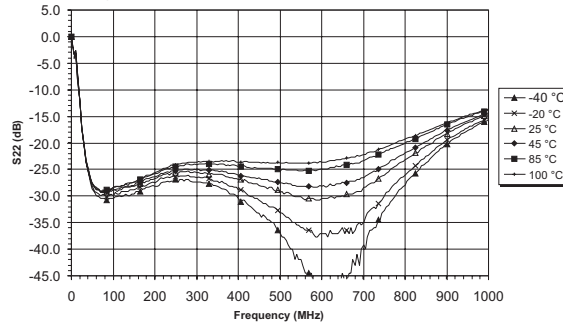

Figure 9: Output Return Loss / S22



ACA0861A and ACA0861B Cascade Typical Data (see Figure 42)

Figure 10: CTB (77 Channel Loading, Flat)

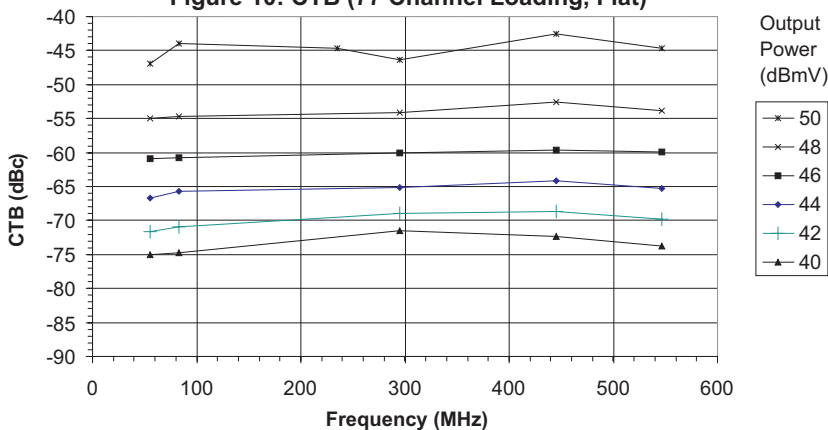

Figure 11: CSO (77 Channel Loading, Flat)

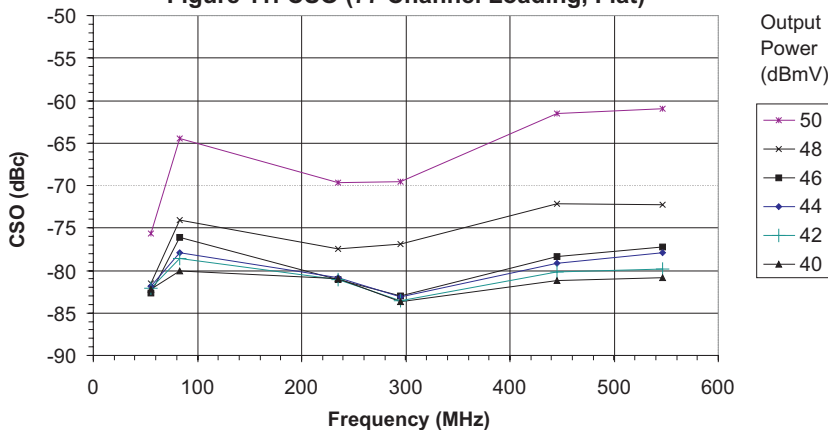
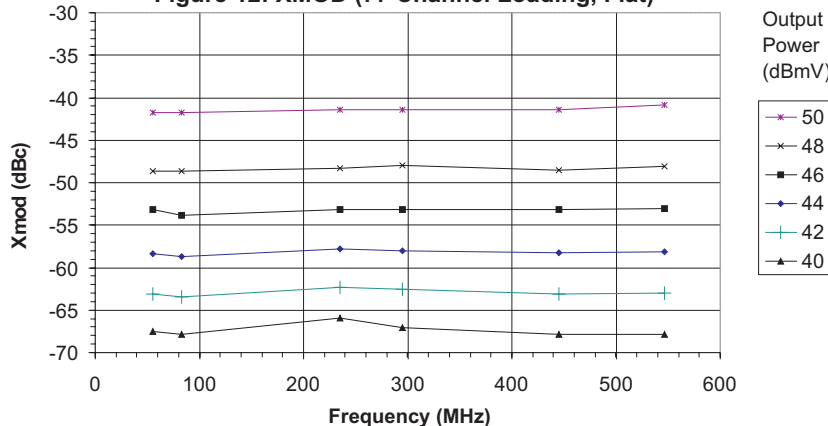
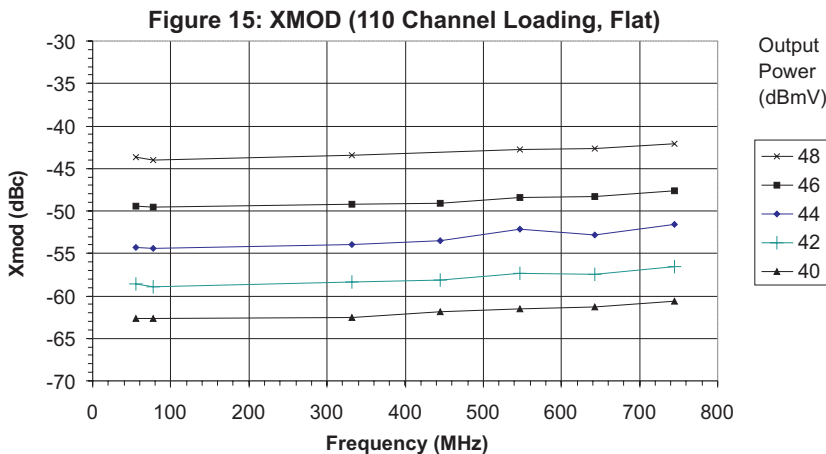
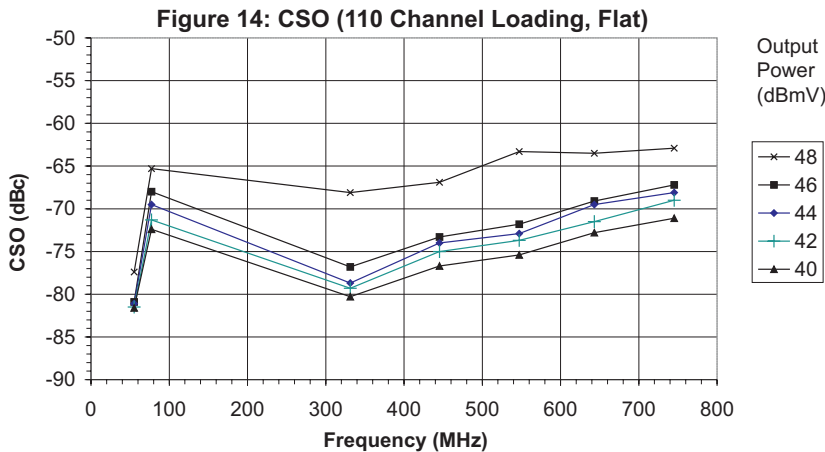
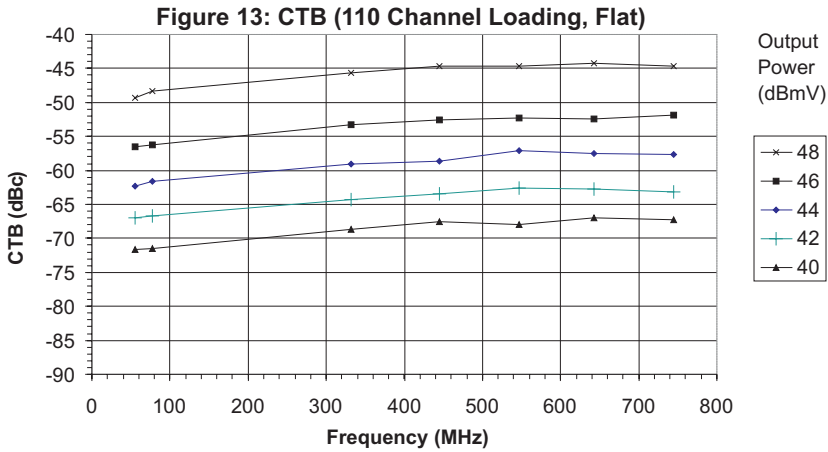

Figure 12: XMOD (77 Channel Loading, Flat)



ACA0861A and ACA0861B Cascade Typical Data (see Figure 42)



ACA0861A and ACA0861B Cascade Typical Data (see Figure 42)

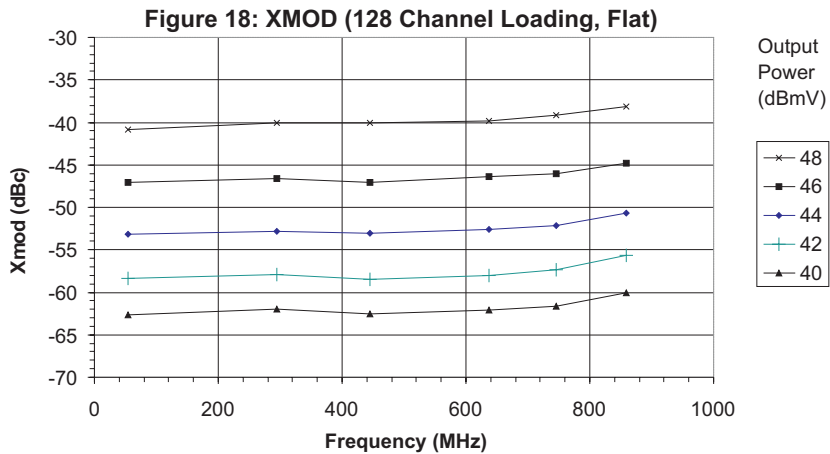
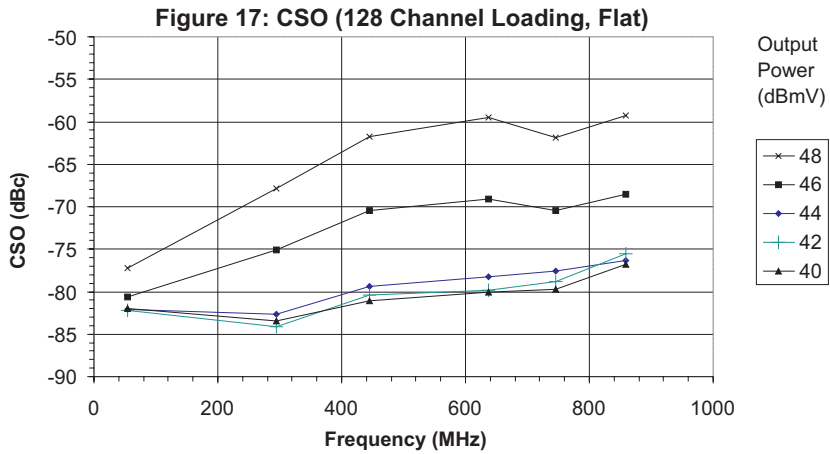
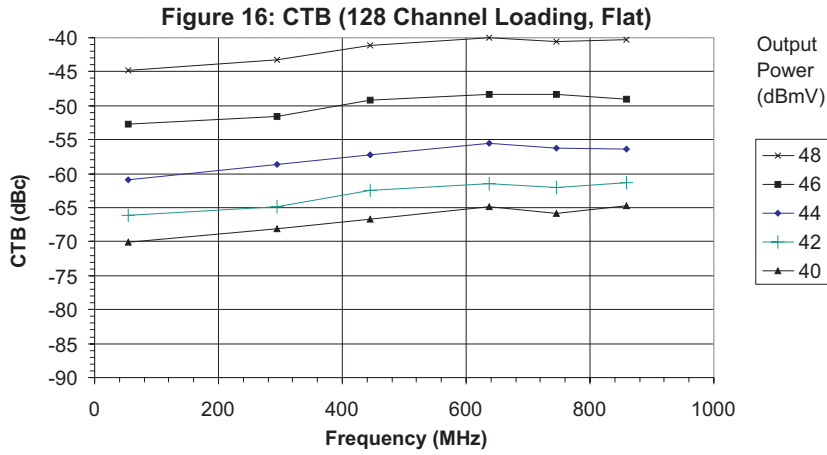

ACA0861C and ACA0861D Cascade Typical Data (see Figure 42)

Figure 19: Gain / S21

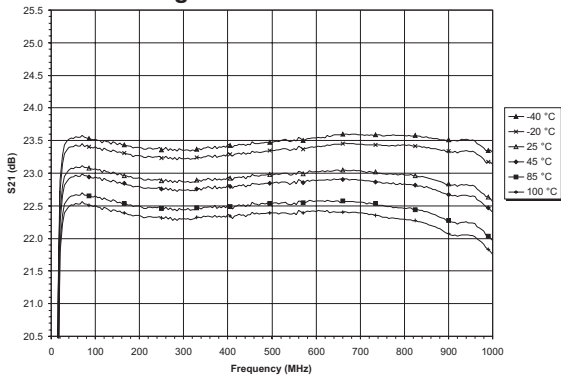

Figure 20: Reverse Isolation / S12

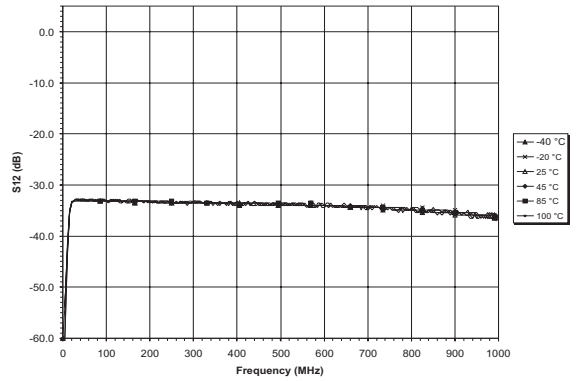

Figure 21: Input Return Loss / S11

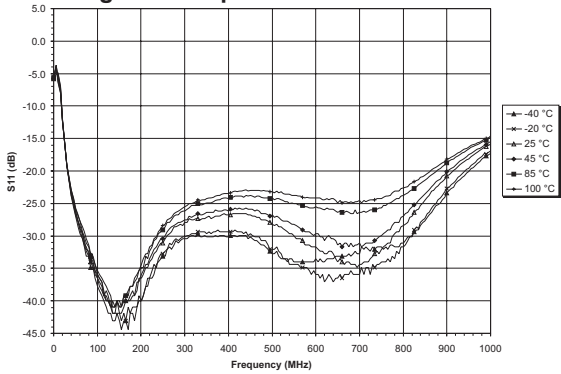

Figure 22: Noise Figure vs. Frequency

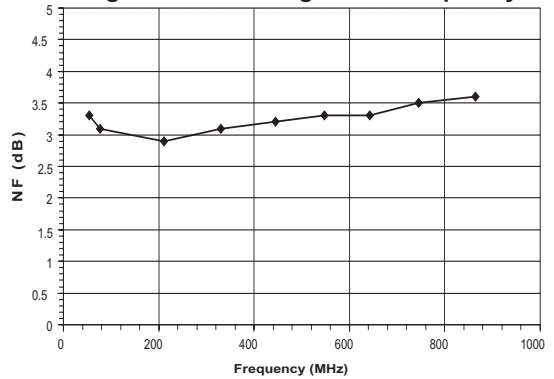
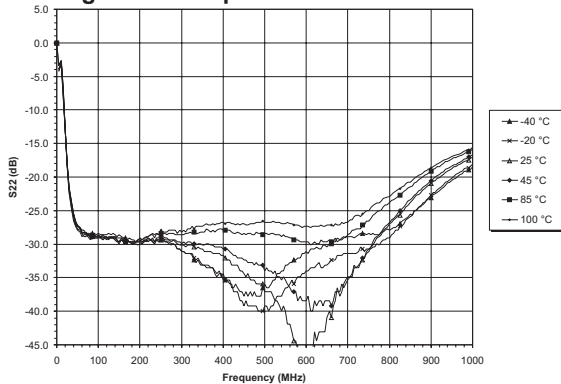

Figure 23: Output Return Loss / S22



ACA0861C and ACA0861D Cascade Typical Data (see Figure 42)

Figure 24: CTB (77 Channel Loading, Flat)

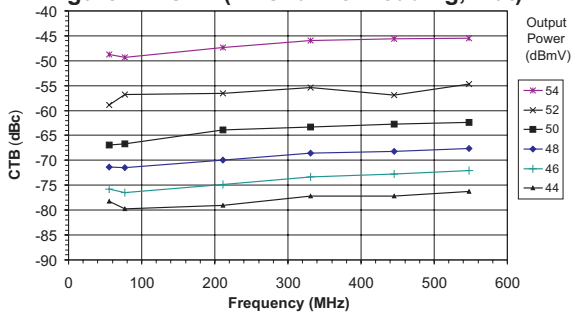

Figure 25: CTB (110 Channel Loading, Flat)

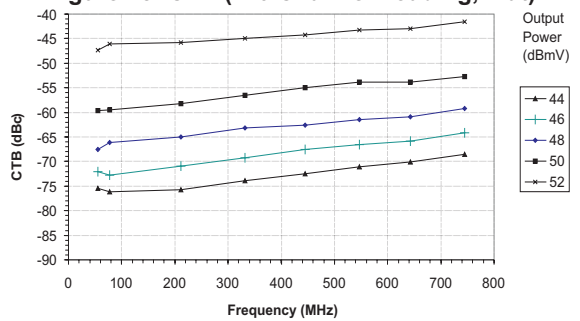

Figure 26: CSO (77 Channel Loading, Flat)

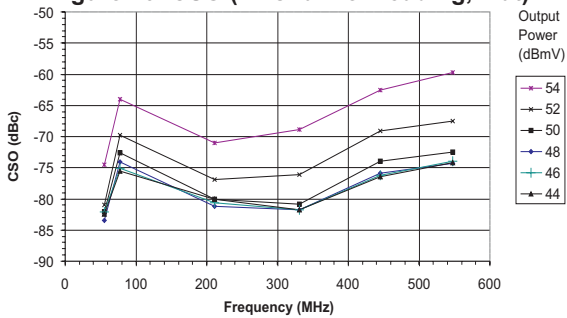

Figure 27: CSO (110 Channel Loading, Flat)

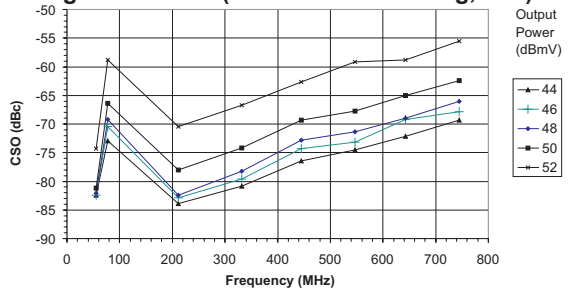

Figure 28: XMOD (77 Channel Loading, Flat)

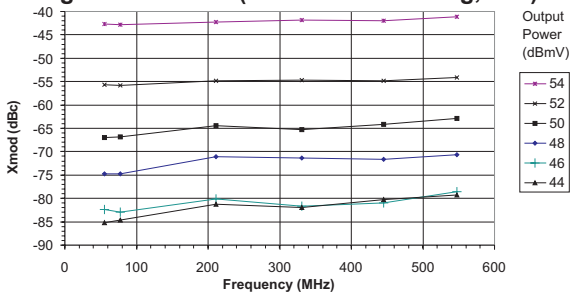
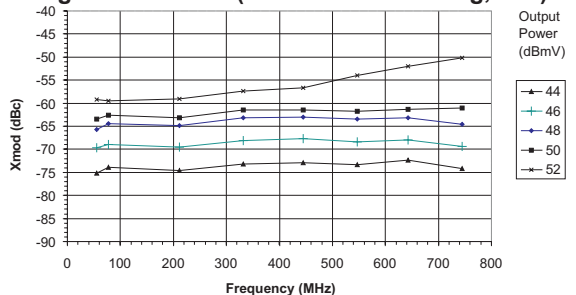

Figure 29: XMOD (110 Channel Loading, Flat)



ACA0861C and ACA0861D Cascade Typical Data (see Figure 42)

Figure 30: CTB (128 Channel Loading, Flat)

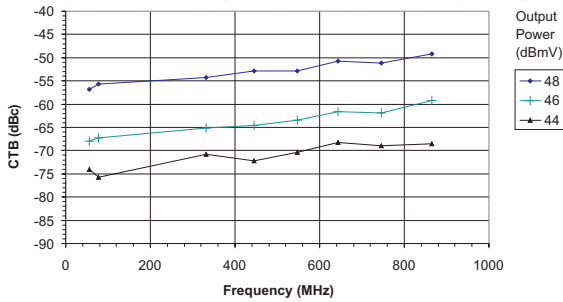

Figure 31: CTB (77 Channel Loading, 8 dB Tilt)

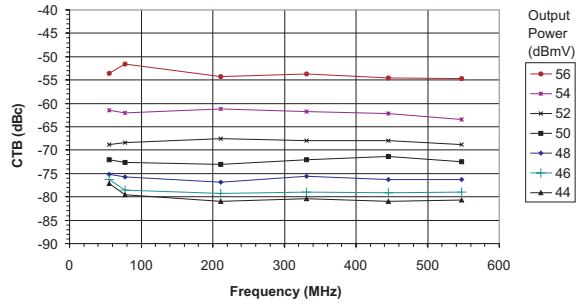

Figure 32: CSO (128 Channel Loading, Flat)

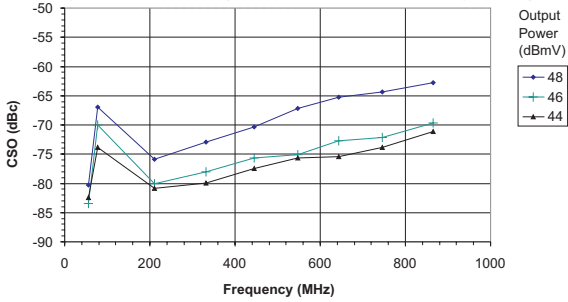

Figure 33: CSO (77 Channel Loading, 8 dB Tilt)

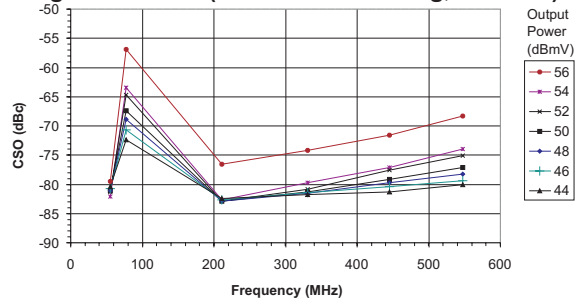

Figure 34: XMOD (128 Channel Loading, Flat)

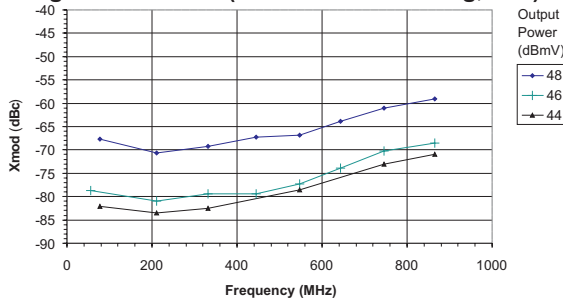
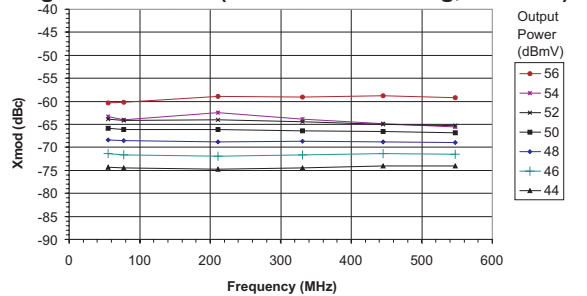

Figure 35: XMOD (77 Channel Loading, 8 dB Tilt)



ACA0861C and ACA0861D Cascade Typical Data (see Figure 42)

Figure 36: CTB (110 Channel Loading, 10 dB Tilt)

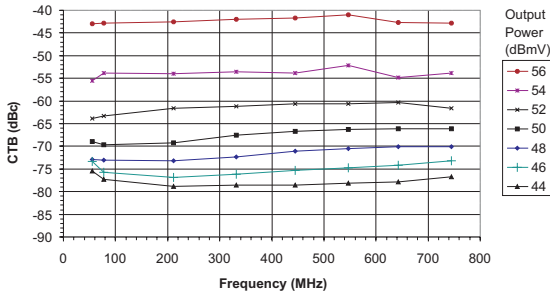

Figure 37: CTB (128 Channel Loading, 12 dB Tilt)

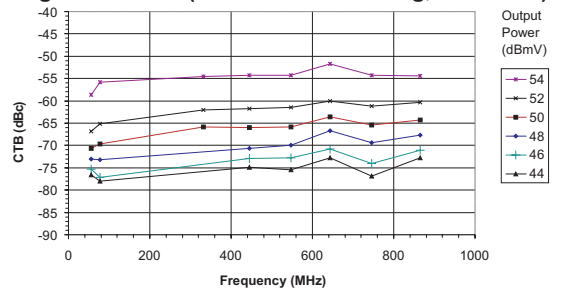

Figure 38: CSO (110 Channel Loading, 10 dB Tilt)

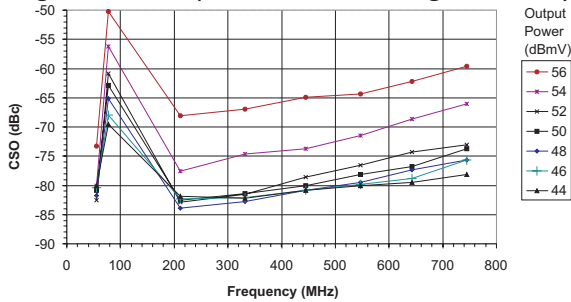

Figure 39: CSO (128 Channel Loading, 12 dB Tilt)

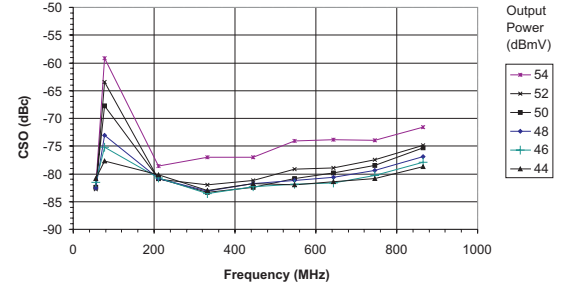

Figure 40: XMOD (110 Channel Loading, 10 dB Tilt)

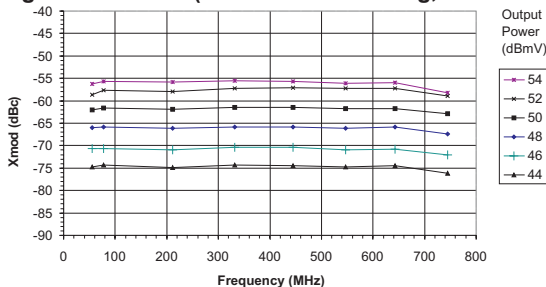
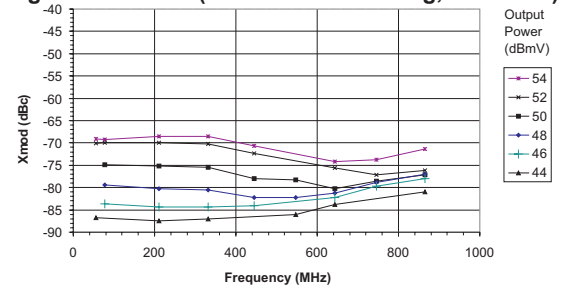
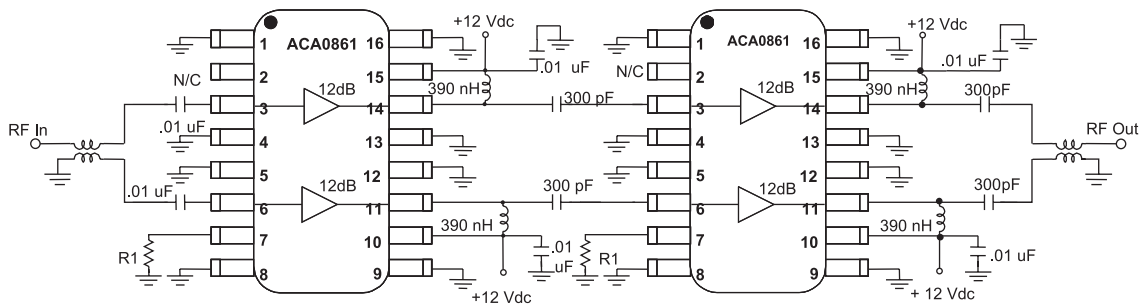

Figure 41: XMOD (128 Channel Loading, 12 dB Tilt)



APPLICATION INFORMATION



Notes:

1. Apply voltage to all +12 Vdc lines simultaneously.
2. See Table 6 for R1 values.
3. Input and output baluns: wind 5 turns thru core (see Table 7), as shown in Figure 43.

Figure 42: Hybrid Equivalent Test Circuit

Table 7: Parts List for Balun (5 Turns)

PART	VENDOR	VENDOR PART NO.
ferrite core	Philips	TC3.4/1.8/1.3-3D3
wire	MWS Wire industries	B238611

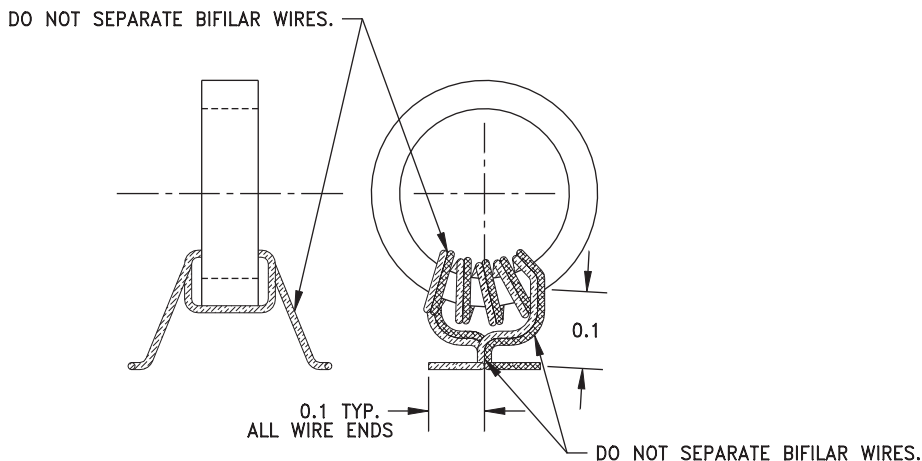

NOTES: 1. MATERIAL:

- CORE: PHILLIPS (135 CT 050-3D3)
- WIRE: MWS WIRE IND.
B2383611(66256-01)
5 TIMES THRU CENTER
AS SHOWN IN FIGURE.

Figure 43: Balun Drawing (5 Turns)

PACKAGE OUTLINE

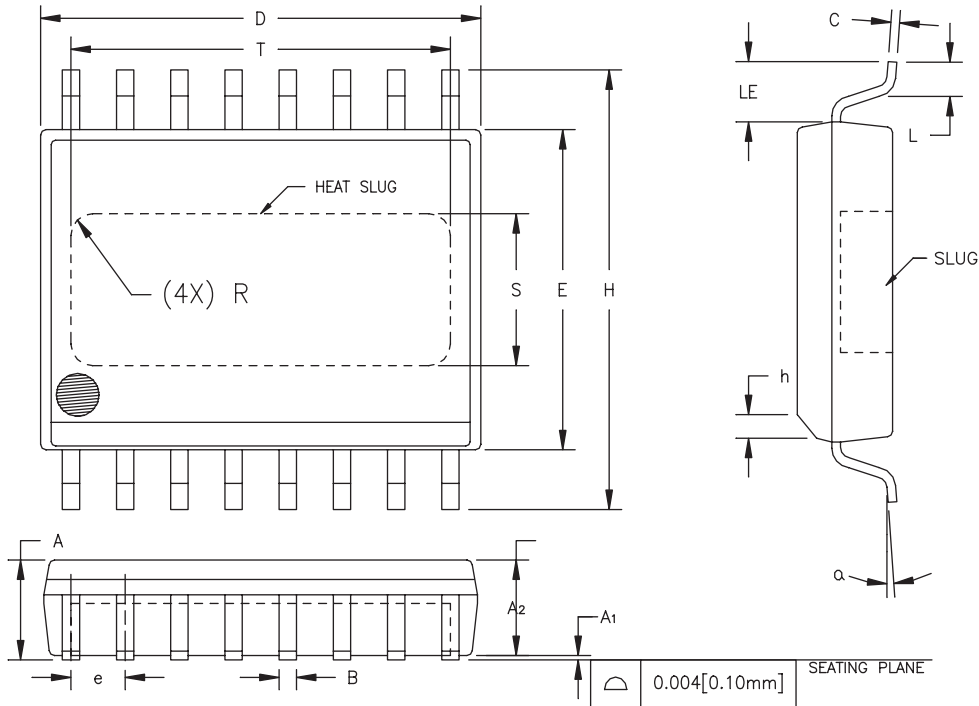

SYMBOL	INCHES		MILLIMETERS		NOTE
	MIN.	MAX.	MIN.	MAX.	
A	0.087	0.098	2.21	2.49	
A ₁	0.000	0.004	0.00	0.10	6
A ₂	0.087	0.094	2.21	2.39	
B	0.013	0.019	0.33	0.48	
C	0.007	0.009	0.18	0.23	
D	0.398	0.412	10.11	10.46	2
E	0.290	0.300	7.37	7.62	3
e	0.050	BSC	1.27	BSC	4
H	0.394	0.418	10.01	10.62	
h	0.010	0.028	0.25	0.71	
L	0.024	0.040	0.61	1.02	
LE	0.052	—	1.32	—	
α	0°	8°	0°	8°	
S	0.120	0.140	3.05	3.56	5
T	0.330	0.350	8.38	8.89	5
R	REF.	0.015	REF.	0.38	5

NOTES:

1. CONTROLLING DIMENSION: INCHES
2. DIMENSION "D" DOES NOT INCLUDE MOLD FLASH, PROTRUSIONS OR GATE BURRS. MOLD FLASH, PROTRUSIONS AND GATE BURRS SHALL NOT EXCEED 0.006 [0.15mm] PER SIDE.
3. DIMENSION "E" DOES NOT INCLUDE INTER-LEAD FLASH OR PROTRUSIONS. INTER-LEAD FLASH AND PROTRUSIONS SHALL NOT EXCEED 0.010 [0.25mm] PER SIDE.
4. MAXIMUM LEAD TWIST/SKEW TO BE ±0.005 [0.13mm].
5. DIMENSIONS "S", "T" AND "R" INDICATE EXPOSED SLUG AREA.
6. STANDOFF HEIGHT (A₁) MEASURED FROM BOTTOM OF SLUG.

Figure 44: S7 Package Outline - 16 Pin Wide Body SOIC with Heat Slug

ORDERING INFORMATION

ORDER NUMBER	TEMPERATURE RANGE	PACKAGE DESCRIPTION	COMPONENT PACKAGING
ACA0861AS7CTR	-40 to 110 °C	16 Pin wide Body SOIC with Heat Slug	1,500 piece tape and reel
ACA0861ARS7P2	-40 to 110 °C	RoHS-Compliant 16 Pin wide Body SOIC with Heat Slug	1,500 piece tape and reel
ACA0861BS7CTR	-40 to 110 °C	16 Pin wide Body SOIC with Heat Slug	1,500 piece tape and reel
ACA0861BRS7P2	-40 to 110 °C	RoHS-Compliant 16 Pin wide Body SOIC with Heat Slug	1,500 piece tape and reel
ACA0861CS7CTR	-40 to 110 °C	16 Pin wide Body SOIC with Heat Slug	1,500 piece tape and reel
ACA0861CRS7P2	-40 to 110 °C	RoHS-Compliant 16 Pin wide Body SOIC with Heat Slug	1,500 piece tape and reel
ACA0861DS7CTR	-40 to 110 °C	16 Pin wide Body SOIC with Heat Slug	1,500 piece tape and reel
ACA0861DRS7P2	-40 to 110 °C	RoHS-Compliant 16 Pin wide Body SOIC with Heat Slug	1,500 piece tape and reel

NOTES

Copyright © 2016 Skyworks Solutions, Inc. All Rights Reserved.

Information in this document is provided in connection with Skyworks Solutions, Inc. ("Skyworks") products or services. These materials, including the information contained herein, are provided by Skyworks as a service to its customers and may be used for informational purposes only by the customer. Skyworks assumes no responsibility for errors or omissions in these materials or the information contained herein. Skyworks may change its documentation, products, services, specifications or product descriptions at any time, without notice. Skyworks makes no commitment to update the materials or information and shall have no responsibility whatsoever for conflicts, incompatibilities, or other difficulties arising from any future changes.

No license, whether express, implied, by estoppel or otherwise, is granted to any intellectual property rights by this document. Skyworks assumes no liability for any materials, products or information provided hereunder, including the sale, distribution, reproduction or use of Skyworks products, information or materials, except as may be provided in Skyworks Terms and Conditions of Sale.

THE MATERIALS, PRODUCTS AND INFORMATION ARE PROVIDED "AS IS" WITHOUT WARRANTY OF ANY KIND, WHETHER EXPRESS, IMPLIED, STATUTORY, OR OTHERWISE, INCLUDING FITNESS FOR A PARTICULAR PURPOSE OR USE, MERCHANTABILITY, PERFORMANCE, QUALITY OR NON-INFRINGEMENT OF ANY INTELLECTUAL PROPERTY RIGHT; ALL SUCH WARRANTIES ARE HEREBY EXPRESSLY DISCLAIMED. SKYWORKS DOES NOT WARRANT THE ACCURACY OR COMPLETENESS OF THE INFORMATION, TEXT, GRAPHICS OR OTHER ITEMS CONTAINED WITHIN THESE MATERIALS. SKYWORKS SHALL NOT BE LIABLE FOR ANY DAMAGES, INCLUDING BUT NOT LIMITED TO ANY SPECIAL, INDIRECT, INCIDENTAL, STATUTORY, OR CONSEQUENTIAL DAMAGES, INCLUDING WITHOUT LIMITATION, LOST REVENUES OR LOST PROFITS THAT MAY RESULT FROM THE USE OF THE MATERIALS OR INFORMATION, WHETHER OR NOT THE RECIPIENT OF MATERIALS HAS BEEN ADVISED OF THE POSSIBILITY OF SUCH DAMAGE.

Skyworks products are not intended for use in medical, lifesaving or life-sustaining applications, or other equipment in which the failure of the Skyworks products could lead to personal injury, death, physical or environmental damage. Skyworks customers using or selling Skyworks products for use in such applications do so at their own risk and agree to fully indemnify Skyworks for any damages resulting from such improper use or sale.

Customers are responsible for their products and applications using Skyworks products, which may deviate from published specifications as a result of design defects, errors, or operation of products outside of published parameters or design specifications.

Customers should include design and operating safeguards to minimize these and other risks. Skyworks assumes no liability for applications assistance, customer product design, or damage to any equipment resulting from the use of Skyworks products outside of stated published specifications or parameters.

Skyworks and the Skyworks symbol are trademarks or registered trademarks of Skyworks Solutions, Inc., in the United States and other countries. Third-party brands and names are for identification purposes only, and are the property of their respective owners. Additional information, including relevant terms and conditions, posted at www.skyworksinc.com, are incorporated by reference.

Skyworks Solutions, Inc.

Phone [781] 376-3000 • Fax [781] 376-3100 • sales@skyworksinc.com • www.skyworksinc.com

Skyworks Proprietary and Confidential information • Products and Product Information are Subject to Change Without Notice