

Ceramic Low Pass Filter

LFCW-143+

50Ω DC to 14 GHz



Generic photo used for illustration purposes only
CASE STYLE: JC0603C-1

The Big Deal

- Good rejection, 32 dB typical
- Rugged, ceramic construction
- Tiny size, 0.063 x 0.032 x 0.024" (0603)
- Good power handling, 2.5W

Product Overview

Mini-Circuits' LFCW-143+ is an LTCC low pass filter with a passband from DC to 14 GHz, supporting a variety of applications. This model provides 1.2 dB typical passband insertion loss and provides a very good stopband rejection due to strategically constructed layout with minimal interaction between components. It handles up to 2.5W RF input power and provides a wide operating temperature range from -55 to +125°C. Housed in a tiny 0603 ceramic form factor with wraparound terminations, the filter is ideal for dense PCB layouts and with minimal performance variation due to parasitics.

Key Features

Feature	Advantages
Ultra-wide stopband	The LTCC lowpass filter provides a very good stopband rejection until 26.5 GHz suitable for high end applications.
LTCC Construction	Provides repeatable performance in a rugged, ceramic package well suited for tough environments such as high humidity and temperature extremes.
Tiny size (0.063 x 0.032 x 0.024")	Saves space in dense circuit board layouts and minimizes the effects of parasitics.
Good power handling, 2.5W	Supports a wide range of system power requirements.
Wrap-around terminations	Provides excellent solderability and easy visual inspection

Notes

- A. Performance and quality attributes and conditions not expressly stated in this specification document are intended to be excluded and do not form a part of this specification document.
B. Electrical specifications and performance data contained in this specification document are based on Mini-Circuit's applicable established test performance criteria and measurement instructions.
C. The parts covered by this specification document are subject to Mini-Circuits standard limited warranty and terms and conditions (collectively, "Standard Terms"); Purchasers of this part are entitled to the rights and benefits contained therein. For a full statement of the Standard Terms and the exclusive rights and remedies thereunder, please visit Mini-Circuits' website at www.minicircuits.com/MCLStore/terms.jsp



Low Pass Filter

LFCW-143+

50Ω DC to 14 GHz

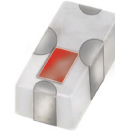

Generic photo used for illustration purposes only
CASE STYLE: JC0603C-1

+RoHS Compliant
The +Suffix identifies RoHS Compliance. See our web site for RoHS Compliance methodologies and qualifications

Features

- Low loss, 1.1 dB typical
- Good rejection 32 dB typical
- Extremely small size 0603 (0.063 X 0.032 X 0.024")
- Temperature stable
- LTCC construction

Application

- Test and measurements
- Telecommunications and broadband wireless system
- Military applications
- Satcom modems

Electrical Specifications^{1,2} at 25°C

Parameter	F#	Frequency (MHz)	Min.	Typ.	Max.	Unit	
Pass Band	Insertion Loss	DC-F1	DC - 14000	—	1.1	2.1	dB
	Freq. Cut-Off	F2*	16000	—	3.0	—	dB
	Return Loss	DC-F1	DC - 14000	—	12	—	dB
Stop Band	Rejection Loss	F3-F4	19250 - 22000	20	32	—	dB
		F4-F5	22000 - 25000	23	31	—	dB
		F5-F6	25000 - 26500	20	30	—	dB

¹ DC de-coupling capacitors are required in Applications where DC voltage and/or current is present at either input or output ports. Please contact Mini-Circuits for alternatives if DC pass from IN-OUT is required.
² Measured on Mini-Circuits Characterization Test Board TB-LFCW-143+

* Typically, a ±5% frequency deviation from the stated value may occur on a unit-to-unit basis.

Functional Schematic

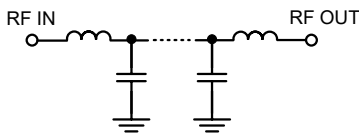

Maximum Ratings

Operating Temperature	-55°C to 125°C
Storage Temperature	-55°C to 125°C
RF Power Input*	2.5 W @25°C

*Passband rating, derate linearly to 0.7 W at 125°C ambient
Permanent damage may occur if any of these limits are exceeded.

Typical Performance Data at 25°C

Frequency (MHz)	Insertion Loss (dB)	Return Loss (dB)
10	0.06	60.05
100	0.05	41.38
1000	0.02	29.35
2000	0.05	27.02
3000	0.06	24.05
5000	0.10	26.57
10000	0.40	19.35
12000	0.57	24.35
14000	1.15	13.72
16000	2.80	12.73
17300	18.49	1.34
18000	30.89	0.90
18500	45.12	0.74
18800	53.01	0.73
19250	42.18	0.63
20000	37.94	0.56
21000	36.21	0.43
22000	34.64	0.32
25000	34.01	0.35
26500	34.11	0.21

Typical Frequency Response

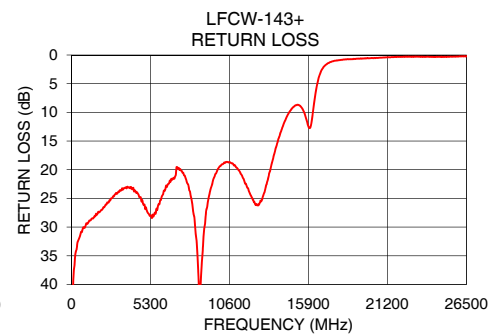
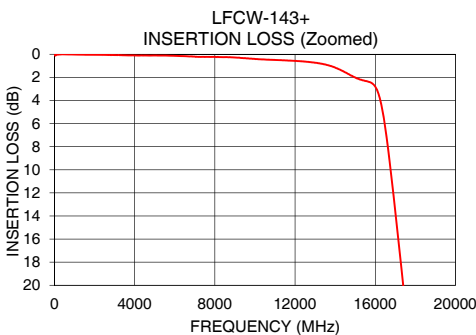
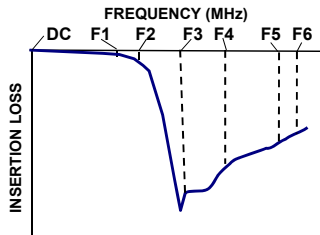

Notes

- Performance and quality attributes and conditions not expressly stated in this specification document are intended to be excluded and do not form a part of this specification document.
- Electrical specifications and performance data contained in this specification document are based on Mini-Circuit's applicable established test performance criteria and measurement instructions.
- The parts covered by this specification document are subject to Mini-Circuits standard limited warranty and terms and conditions (collectively, "Standard Terms"); Purchasers of this part are entitled to the rights and benefits contained therein. For a full statement of the Standard Terms and the exclusive rights and remedies thereunder, please visit Mini-Circuits' website at www.minicircuits.com/MCLStore/terms.jsp



Pad Connections

INPUT	1
OUTPUT	3
GROUND	2, 4

Product Marking: K

Demo Board MCL P/N: TB-LFCW-143+
Suggested PCB Layout (PL-650)

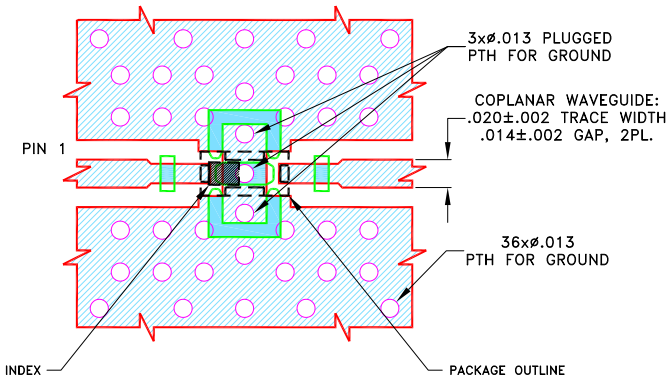

NOTES:

- COPLANAR WAVEGUIDE PARAMETERS ARE SHOWN FOR ROGERS (R04835 Lo Pro) WITH DIELECTRIC THICKNESS .0107 \pm .0010. COPPER: 1/2 Oz. EACH SIDE.
FOR OTHER MATERIALS TRACE WIDTH AND GAP MAY NEED TO BE MODIFIED.
 - BOTTOM SIDE OF THE PCB IS CONTINUOUS GROUND PLANE.
- DENOTES PCB COPPER LAYOUT WITH SMOBC (SOLDER MASK OVER BARE COPPER)
- DENOTES COPPER LAND PATTERN FREE OF SOLDERMASK

Outline Drawing

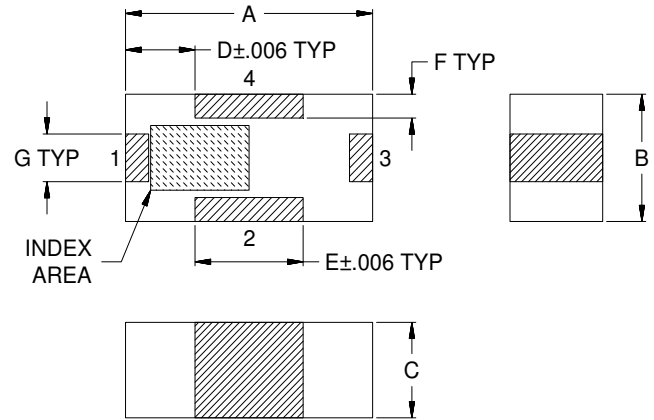

Outline Dimensions (Inch / mm)

A	B	C	D	E	F	G	Wt.
.063	.032	.024	.018	.028	.006	.012	grams
1.60	0.80	0.60	0.45	0.70	0.15	0.30	.005

Note: Please refer to case style drawing for details

Notes

- A. Performance and quality attributes and conditions not expressly stated in this specification document are intended to be excluded and do not form a part of this specification document.
- B. Electrical specifications and performance data contained in this specification document are based on Mini-Circuit's applicable established test performance criteria and measurement instructions.
- C. The parts covered by this specification document are subject to Mini-Circuits standard limited warranty and terms and conditions (collectively, "Standard Terms"); Purchasers of this part are entitled to the rights and benefits contained therein. For a full statement of the Standard Terms and the exclusive rights and remedies thereunder, please visit Mini-Circuits' website at www.minicircuits.com/MCLStore/terms.jsp